

Type 702042



Type 702044



Type 702041



Type 702043



Type 702040

JUMO iTRON

Compact micro-processor controllers

B 70.2040 Operating Instructions

07.05/00357918



Please read these Operating Instructions carefully before starting up the instrument. Keep these operating instructions in a place which is at all times accessible to all users. Please assist us to improve these operating instructions where necessary. Your suggestions will be most welcome.

Phone in Germany (0661) 6003-727
 from abroad (+49) 661 6003-0
Fax in Germany (0661) 6003-508
 abroad (+49) 661 6003-607



All necessary settings are described in these operating instructions. However, if any difficulties should still arise during start-up, you are asked not to carry out any unauthorized manipulations on the unit. You could endanger your rights under the instrument warranty! Please contact the nearest subsidiary or the main factory in such a case.

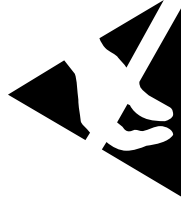

When returning chassis, assemblies or components, the regulations of EN 100 015 “Protection of electrostatically sensitive components” must be observed. Use only the appropriate **ESD** packaging for transport.

Please note that we cannot accept any liability for damage caused by ESD (electrostatic discharge).

Contents

1	Identifying the instrument version	4
2	Installation	6
3	Electrical connection	7
4	Operation	12
	4.1 Displays and keys	12
	4.2 Principle of operation	13
	4.3 Operation of the timer function	15
5	Functions	16
	5.1 Process value input	17
	5.2 Logic input	18
	5.3 Controller	19
	5.4 Limit comparator (alarm contact)	21
	5.5 Ramp function	22
	5.6 Self-optimization	23
	5.7 Level inhibit via code	24
	5.8 Timer function (extra code)	25
6	Configuration and parameter tables	31
7	Alarm messages	37
8	Technical data	39

1 Identifying the instrument version

7020 / (1) (2) (3) (4) (5) (6) ,...

(1)	Basic type (bezel in mm)	40 = 48 x 24, 41 = 48 x 48, 42 = 48 x 96 (portrait), 43 = 96 x 48 (landscape), 44 = 96 x 96
(2)	Basic type extension	88 = controller type configurable ¹ 99 = controller type configured to customer specification ²
(3)	Inputs	888 = inputs configurable ¹ 999 = inputs configured to customer specification ²
(4)	Outputs	Type 702040/41
	Output 1	relay (n.o. make)
	Output 2	logic 0/5V, optionally configurable als logic input
	Output 3	(not available)
	Options	Type 702040/41
	113 = Output 2 (outputs 1+3 as for Standard)	logic 0/12V, optionally configurable als logic input
	101 = Output 2 (output 1 as for Standard)	relay (n.o. make) (logic input is always available)
		Type 702042/43/44
		relay (n.o. make)
		logic 0/5V
		relay (n.o. make)
		Type 702042/43/44
		logic 0/12V
		not possible

1. single-setpoint controller with limit comparator, see factory settings under configuration and parameter level

2. see customer's ordering text or settings under configuration and parameter level

(5)	Supply	<p>16 = 10 – 18V DC 22 = 20 – 53V AC/DC, 48 – 63Hz 23 = 110 – 240V -15/+10% AC 48 – 63Hz</p>									
(6)	Extra code	<p>061 = cUL/UL approval (Underwriter Laboratories) 068 = FM + cUL/UL approval 210 = Timer function 220 = Timer function + limit switch¹</p>									
Delivery package		<table border="1"> <tr> <td data-bbox="449 1168 511 1749"></td> <td data-bbox="449 657 511 1168">Type 702040/41</td> <td data-bbox="449 220 511 657">Type 702042/43/44</td> </tr> <tr> <td data-bbox="511 1168 572 1749"></td> <td data-bbox="511 657 572 1168">1 mounting frame</td> <td data-bbox="511 220 572 657">2 mounting brackets</td> </tr> <tr> <td data-bbox="572 1168 628 1749"></td> <td colspan="2" data-bbox="572 220 628 1168">1 seal, 1 Operating instructions 70.2040</td> </tr> </table>		Type 702040/41	Type 702042/43/44		1 mounting frame	2 mounting brackets		1 seal, 1 Operating instructions 70.2040	
	Type 702040/41	Type 702042/43/44									
	1 mounting frame	2 mounting brackets									
	1 seal, 1 Operating instructions 70.2040										

1. The linearizations for KTY11-6 and thermocouple B have been deleted.

2 Installation

2 Installation

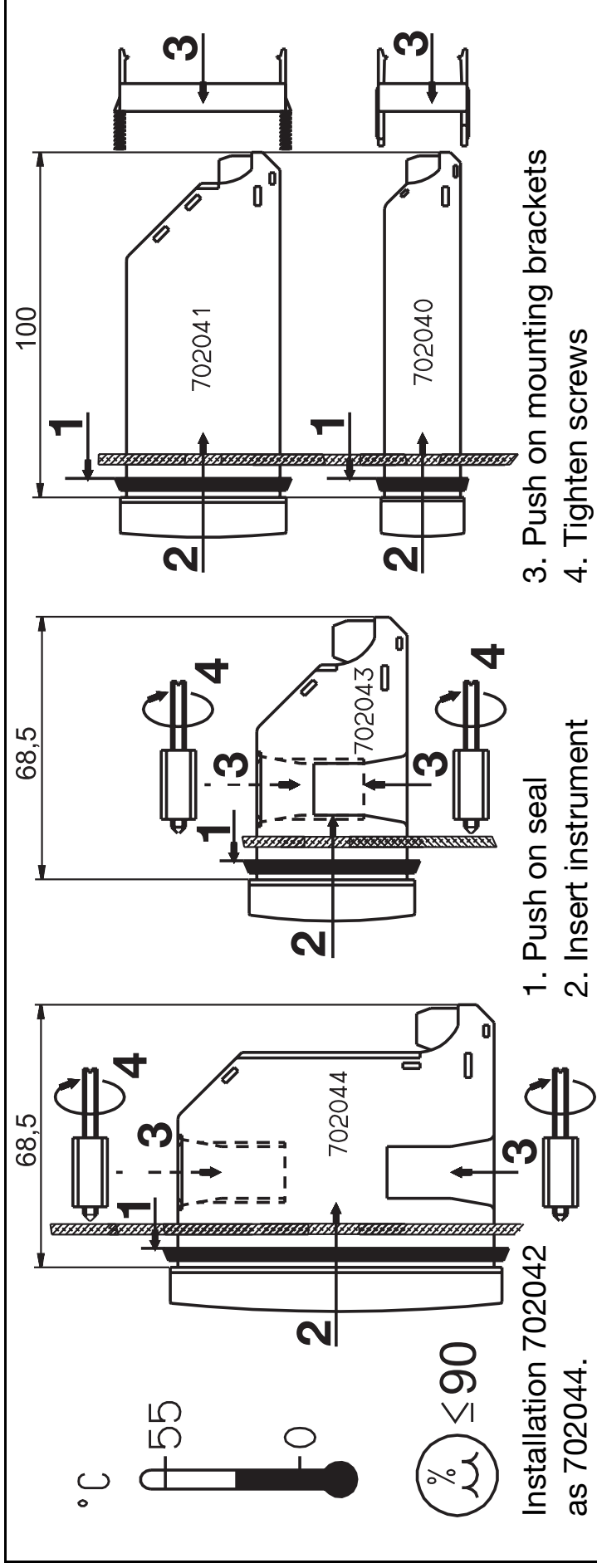

Type (bezel)	Panel cut-out (WxH) in mm	Edge-to-edge-mounting (minimum spacings of panel cut-outs)
		horizontal vertical
702040 (48mm x 24mm)	45 ^{+0.6} x 22.2 ^{+0.3}	> 8mm > 8mm
702041 (48mm x 48mm)	45 ^{+0.6} x 45 ^{+0.6}	> 8mm > 8mm
702042 (48mm x 96mm)	45 ^{+0.6} x 92 ^{+0.8}	> 10mm > 10mm
702043 (96mm x 48mm)	92 ^{+0.8} x 45 ^{+0.6}	> 10mm > 10mm
702044 (96mm x 96mm)	92 ^{+0.8} x 92 ^{+0.8}	> 10mm > 10mm

3 Electrical connection

Installation notes

- The choice of cable, the installation, the fusing and the electrical connection must conform to the requirements of VDE 0100 “Regulations on the Installation of Power Circuits with nominal voltages below 1000V”, or the appropriate local regulations.
- The electrical connection must only be carried out by qualified personnel.
- If contact with live parts is possible when working on the instrument, it must be isolated on both poles from the supply.
- A current limiting resistor interrupts the supply circuit in the event of a short-circuit. The load circuit must be fused for the maximum relay current in order to prevent welding of the output relay contacts in the event of an external short-circuit.
- Electromagnetic compatibility conforms to the standards and regulations listed under Technical Data.
- Run input, output and supply lines separately and not parallel to each other.
- Do not connect any additional loads to the supply terminals of the instrument.
- The instrument is not suitable for installation in hazardous areas.
- Apart from faulty installation, there is a possibility of interference or damage to controlled processes due to incorrect settings on the controller (setpoint, data of parameter and

configuration levels, internal adjustments).

Safety devices independent of the controller, such as overpressure valves or temperature limiters/monitors, should always be provided and should be capable of adjustment only by specialist personnel.

Please refer to the appropriate safety regulations in this connection. Since auto-tuning (self-optimization) cannot be expected to handle all possible control loops, there is a theoretical possibility of unstable parameter settings. The resulting process value should therefore be monitored for its stability.

- All input and output lines that are not connected to the supply network must be laid out as shielded and twisted cables (do not run them in the vicinity of power cables or components). The shielding must be grounded to the earth potential on the instrument side.

Type 702040/41

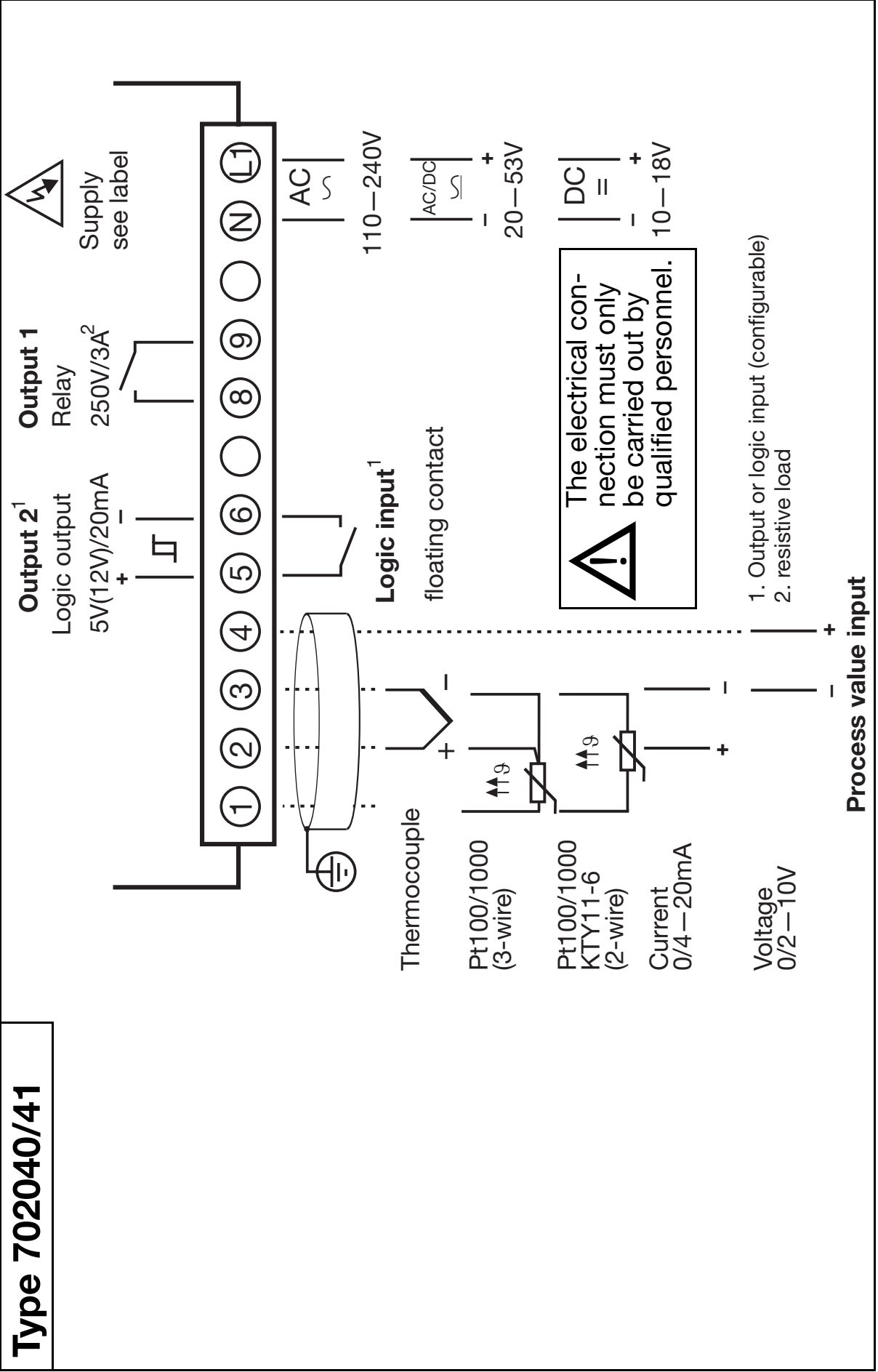

Type 702040/41 with 2 relay outputs (option)

Outputs

Relay 250 V/3 A

Supply see label

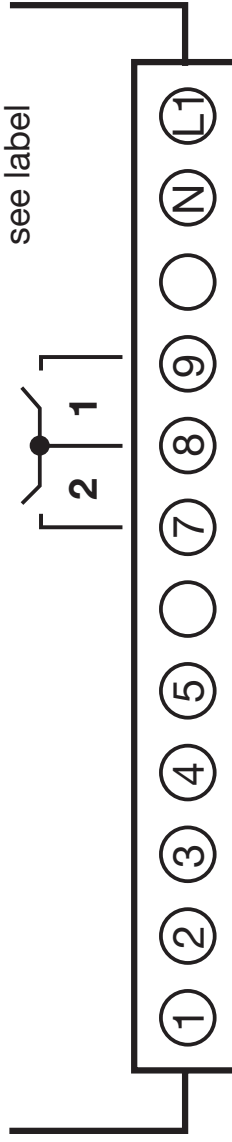

AC 110–240V

AC/DC 20–53V

DC 10–18V

Logic input

Thermocouple

Pt100/1000 (3-wire)

Pt100/1000 KTY11-6 (2-wire)

Current 0/4–20 mA

Voltage 0/0.2–1 V

Process value input

⚠ The electrical connection must only be carried out by qualified personnel.

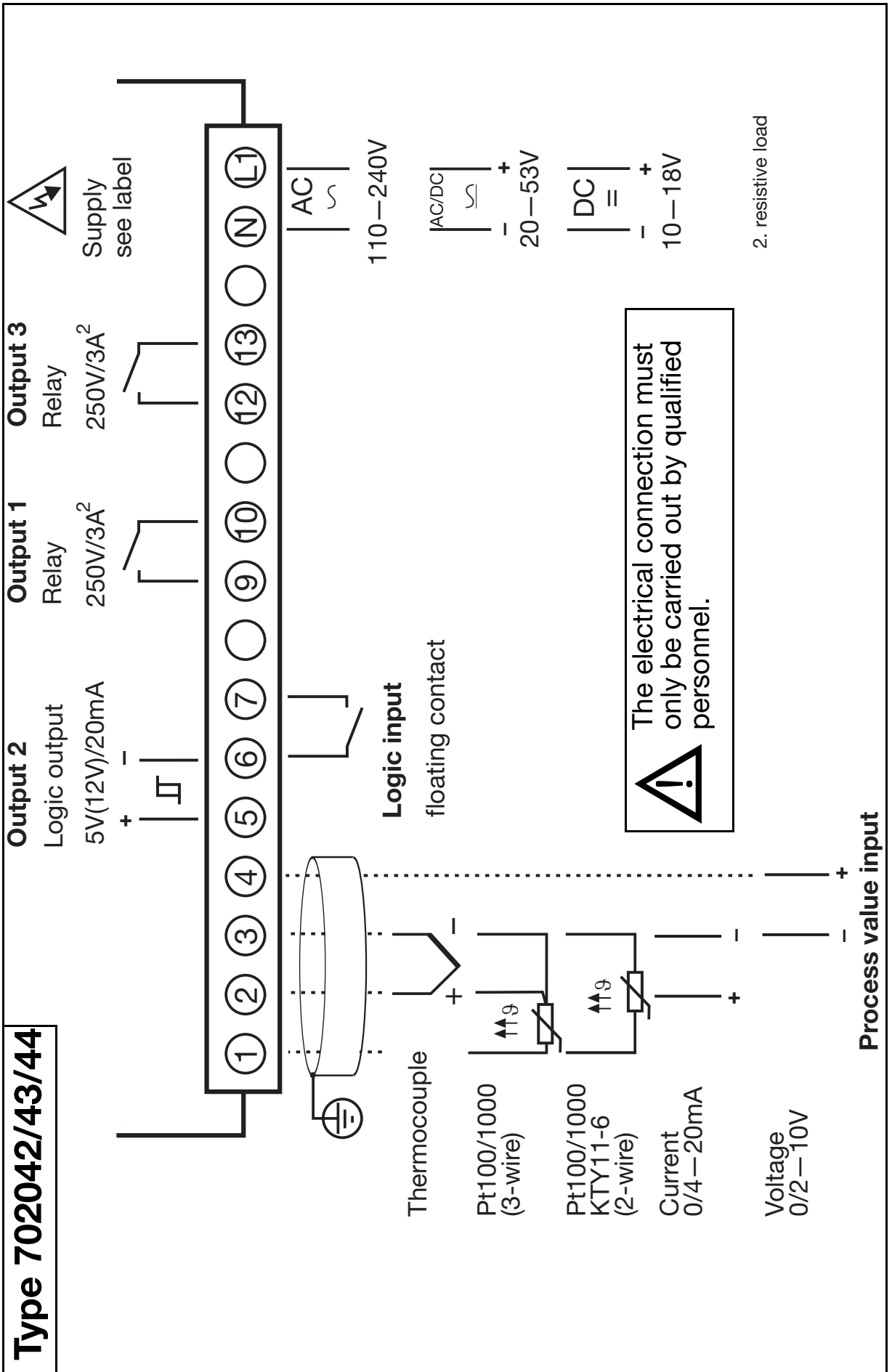

4 Operation

4.1 Displays and keys

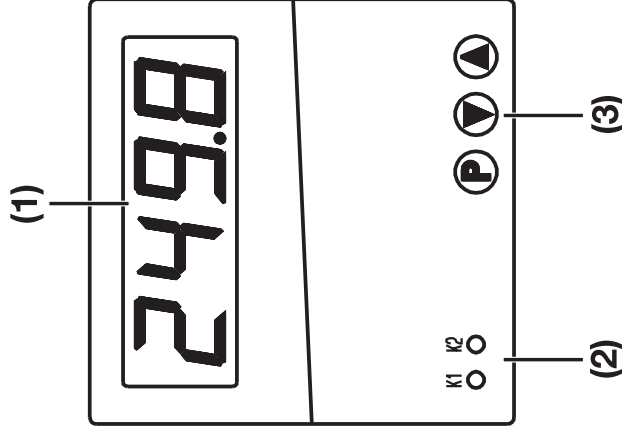

Example: Type 702041

(1) Display

7-segment display	4 places, green Display alternates when setpoints, parameters and codes are entered and indicated.	
Character height	Type 702040/41/42: 10mm Type 702043/44: 20mm	
Display range	-1999 to +9999 digit	
Decimal places	none, one, two	
Unit	° C/ ° F (process value display)	

(2) Status indicators

LED	two LEDs for the outputs 1 and 2, yellow
-----	--

(3) Keys



P, ▲, ▼	for operating and programming the instrument. Dynamic modification of settings and parameters. * Increase value with ▲ * Decrease value with ▼ Automatic value acceptance after 2 seconds.
---------	--

4.2 Principle of operation

Normal display

The display shows the process value.

Operating level

The setpoint SP is input here. On active setpoint switching via the logic input, SP is or SP is appears in the display. When the ramp function is active, the ramp setpoint SP_r is displayed. With activated timer function, the timer value t , or the timer start value t_s is shown. The setpoint is altered dynamically using the  and  keys. The setting will be accepted automatically after approx. 2 sec.

Parameter level

The setpoints, the limit value of the limit comparator, the controller parameters and the ramp slope are programmed here.

Configuration level

The basic functions of the controller are set here.

 **In order to make the settings, it is necessary to change to the configuration level via the parameter y (parameter level).**

Timer level

The current timer value (only when the timer has been started) and the timer start value are entered here. The parameters at this level are marked with an underscore in the display.

Time-out



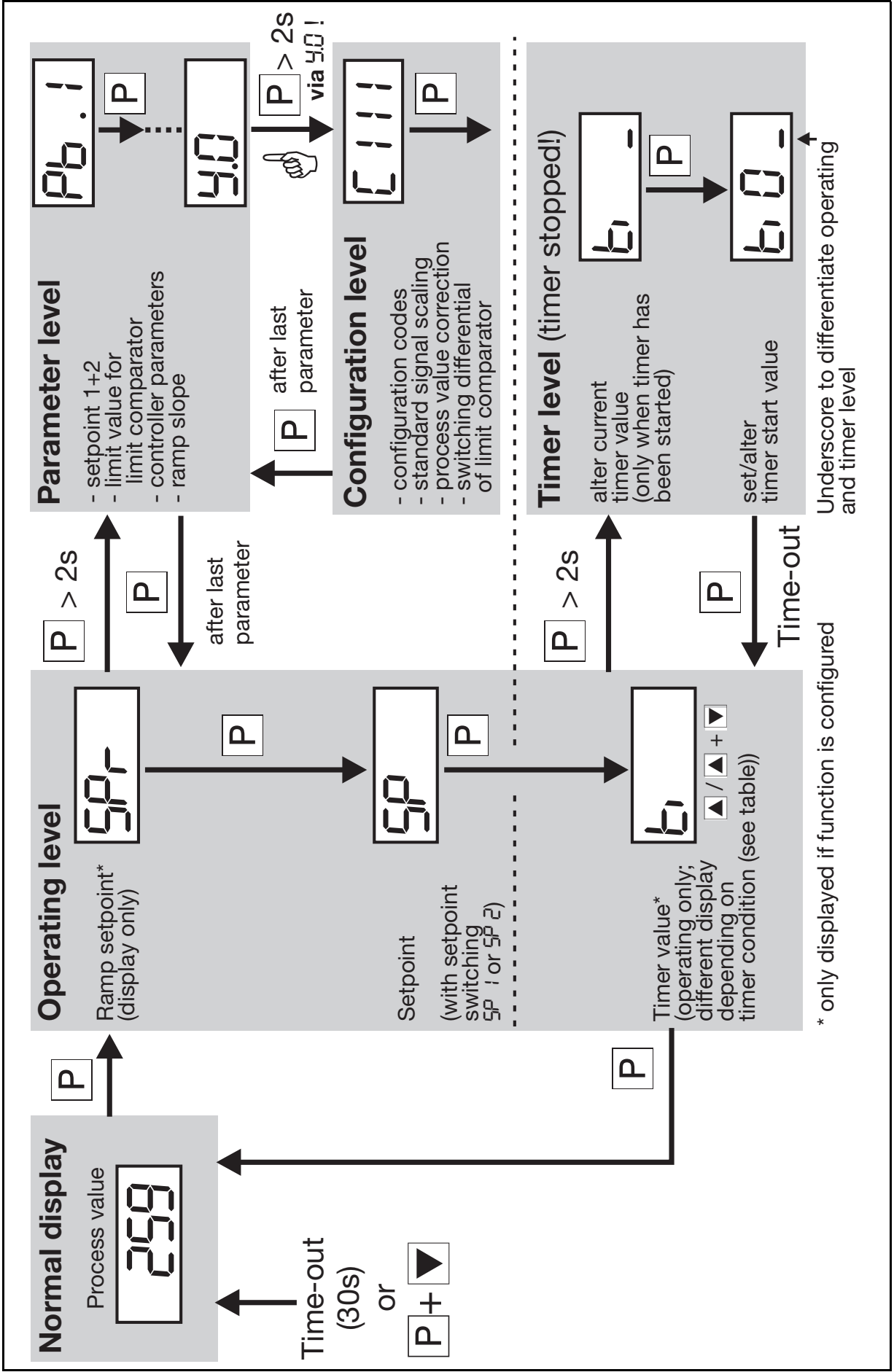







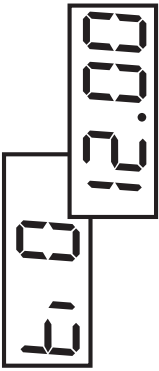

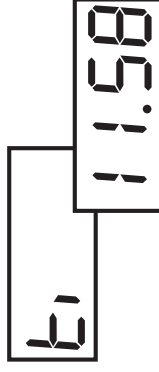

If no operation occurs, the controller returns automatically to normal display after approx. 30 sec (exception: with timer functions starting via power ON, the timer value is displayed). If the timer value is displayed at the operating level, time-out is not active.

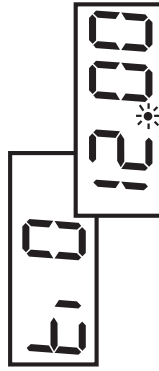

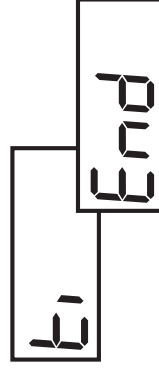
4.3 Operation of the timer function

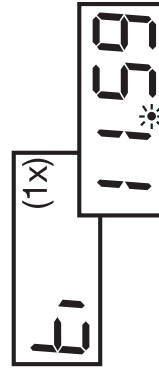
The timer can be operated with the keys (start, stop, cancel, acknowledge) if the timer at operating level is indicated. Time-out is not active here. If the logic input is configured accordingly, then a key, such as the , can be used. In this case, the timer can also be operated even if the timer value does not appear in the display.

Possible displayed parameters for timer function at operating level

Display	State/Action	Display	State/Action
	Timer not running * Start with 		Timer has stopped * Continue with  * Cancel with  + 
	Timer has been started but the tolerance limit has not yet been reached * Cancel with  + 		Timer has run down * Acknowledge with any key (timer start value t_1 is indicated) With time-delayed control (C120=3), acknowledge with  + 
	Timer running; t_1 is displayed * Stop with  * Cancel with  + 	When the timer has been started, the decimal point in the display for the timer value will blink! ✨	

5 Functions

We recommend the following procedure:

- * Familiarize yourself with the controller functions
- * Enter the configuration codes and the parameter values in the tables provided for this purpose in Chapter 6. Write down the appropriate values (✎), or mark selection with a cross (X✎). The parameters and the configuration codes are listed in the order of their appearance. Parameters which are not relevant are masked out (see table below).
- * Enter the configuration code and parameters on the instrument



Configuration	Masking out the parameters for	Parameter
Single-setpoint controller	Double-setpoint controller	Pb 2, Cy 2, db, HYS2
Double-setpoint controller	Limit comp. for Type 702040/41 Logic input for Type 702040/41 ¹	C114, HYS1, AL C117
Limit comparator no function	Limit comparator	HYS1, AL
Limit comparator activated	Logic input for Type 702040/41 ¹	C117
Resistance thermometer, thermocouple	Standard signal scaling	SCL, SCH
Ramp function off	Ramp function	rASd, SPr
Setpoint switching not activated	Setpoints at the parameter level	SP 1, SP 2
Timer function: no function	Timer function	t1, C121, C122, C123
Type 702040/41	Output 3	C118

1. not for Type 702040/41 with 2 relay outputs (option)

5.1 Process value input

Symbol	Notes									
[1 1 1	Transducer/probe (process value input) ⇨ page 31									
[1 1 2	Unit of process value (°C/°F)/decimal places of display ⇨ page 31									
5CL	Start/end value of value range for standard signals ⇨ page 35 Example: 0–20 mA→20–200°C: 5CL = 20 / 5CH = 200									
5CH										
OFF5	Process value correction ⇨ page 35 Using the process value correction, a measured value can be corrected by a programmable amount upwards or downwards (offset). Lead compensation can be implemented in software for 2-wire circuit through process value correction.									
	Examples: <table border="1"> <thead> <tr> <th>Measured value</th> <th>Offset</th> <th>Displayed value</th> </tr> </thead> <tbody> <tr> <td>294.7</td> <td>+ 0.3</td> <td>295.0</td> </tr> <tr> <td>295.3</td> <td>- 0.3</td> <td>295.0</td> </tr> </tbody> </table>	Measured value	Offset	Displayed value	294.7	+ 0.3	295.0	295.3	- 0.3	295.0
Measured value	Offset	Displayed value								
294.7	+ 0.3	295.0								
295.3	- 0.3	295.0								
df	Filter time constant (damping) to adapt the digital input filter (0sec = filter off) ⇨ page 36 if df high: <ul style="list-style-type: none"> - high damping of interference signals - slow reaction of the process value display to changes in the process value - low cut-off frequency (2nd order low-pass filter) 									

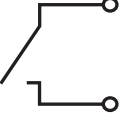
5.2 Logic input

		
Key inhibit	Operation is possible from keys.	No operation from keys.
Level inhibit	Access to the parameter and configuration levels is possible. Starting self-optimization is possible.	No access to the parameter and configuration levels. Starting self-optimization is not possible.
Ramp stop	Ramp running	Ramp stopped
Setpoint switching	Setpoint SP_i is active The appropriate symbols SP_i and SP_i are displayed at the operating level.	Setpoint SP_i is active
Timer control	Acknowledge start/stop/continue/timer run-down (edge-triggered)	

Symbol	Notes
C117	Function of the logic input ⇒ page 33 On Type 702040/41, the parameter C117 is masked out if output 2 has been programmed as controller output (C113) or the limit comparator has been configured (C114) (double assignment; not on Type 702040/41 with 2 relay outputs (option)).



5.3 Controller

Controller structure

The controller structure is defined via the parameters P_b , dt and rt .

Example: Setting for PI controller $\rightarrow P_b = 120$, $dt=0$ sec, $rt=350$ sec

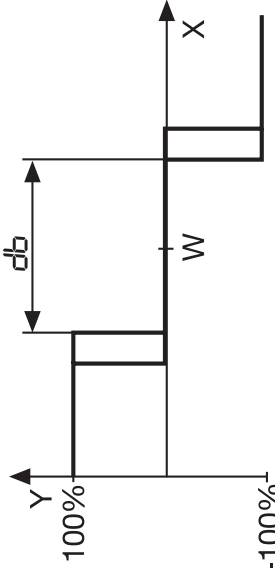
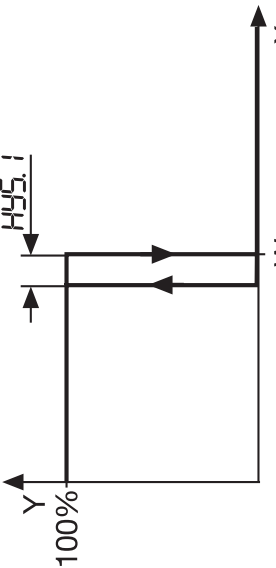
Symbol	Notes
C113	Controller type and assignment of the controller outputs to the physical outputs 1+2 \rightarrow page 32
C116	Outputs in fault condition \rightarrow page 33 The switching states of the outputs are defined here in the event of over/underrange, probe break/short circuit or display overflow. \rightarrow Chapter 7
C118	Assignment of the outputs \rightarrow page 33 Only for Type 702042/43/44; overwrites the assignment of C113 (controller type as C113)
Pb.1	Proportional band 1 (controller output 1) \rightarrow page 36
Pb.2	Proportional band 2 (controller output 2) Influences the P action of the controller. If $P_b=0$, the controller structure is not effective.
dt	Derivative time \rightarrow page 36 Influences the D action of the controller. If $dt=0$, the controller has no D action.
rt	Reset time \rightarrow page 36 Influences the I action of the controller. If $rt=0$, the controller has no I action.
CY 1	Cycle time 1 (controller output 1) \rightarrow page 36
CY 2	Cycle time 2 (controller output 2) The cycle time has to be selected so that the energy supply to the process is virtually continuous, while not subjecting the switching elements to excessive wear.

Symbol	Notes
db	<p>Contact spacing ⇨ page 36 for double-setpoint controller</p> 
HY5.1	<p>Differential 1 (controller output 1) ⇨ page 36</p>
HY5.2	<p>Differential 2 (controller output 2) for controllers with $Pb. i=0$ or $Pb.c=0$</p> 
Y.0	<p>Working point (basic load) ⇨ page 36 Output if process value=setpoint</p>
Y.1	<p>Output limiting ⇨ page 36</p>
Y.2	<p>Y.1 - maximum output Y.2 - minimum output</p> <p> For controllers without controller structure ($Pb. i=0$ or $Pb.c=0$), it is necessary that $Y.1=100\%$ and $Y.2=-100\%$.</p>

5.4 Limit comparator (alarm contact)

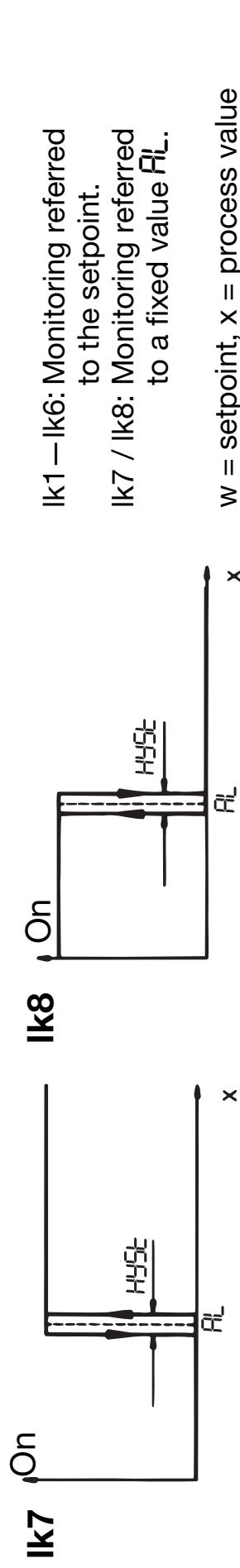
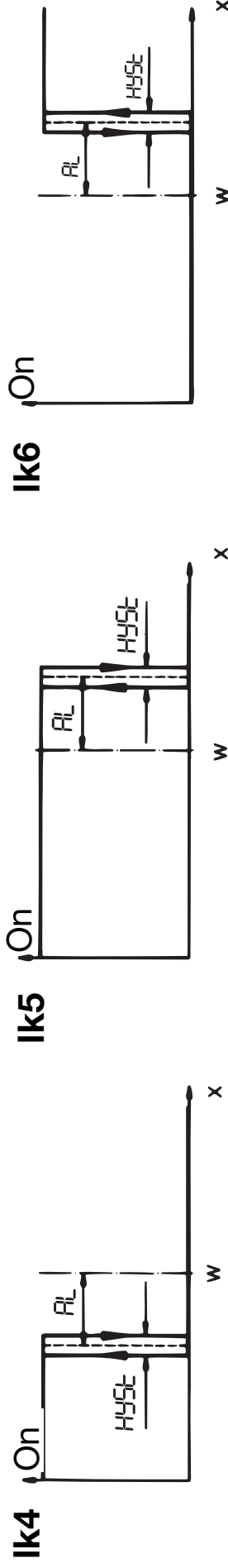
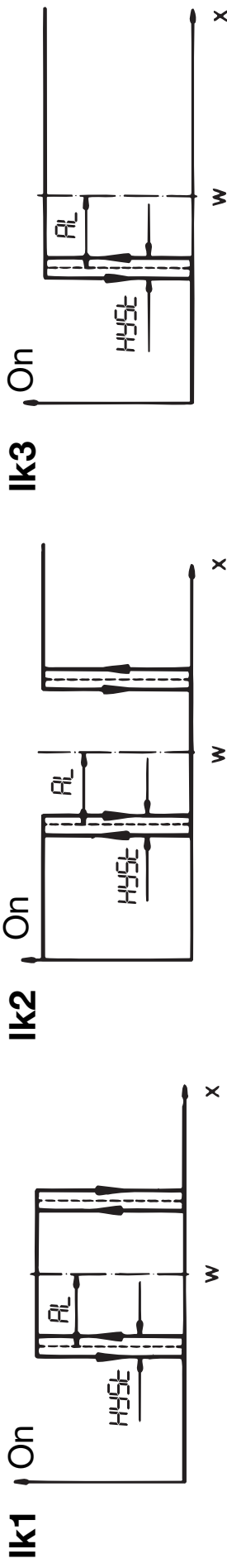

Ik1 — Ik6: Monitoring referred to the setpoint.

Ik7 / Ik8: Monitoring referred to a fixed value RL .

w = setpoint, x = process value

Symbol	Notes
Ik1-8	Limit comparator function (Ik1 — Ik8) ⇨ page 32
HYST	Differential of limit comparator ⇨ page 35
RL	Limit value of limit comparator ⇨ page 36

5.5 Ramp function

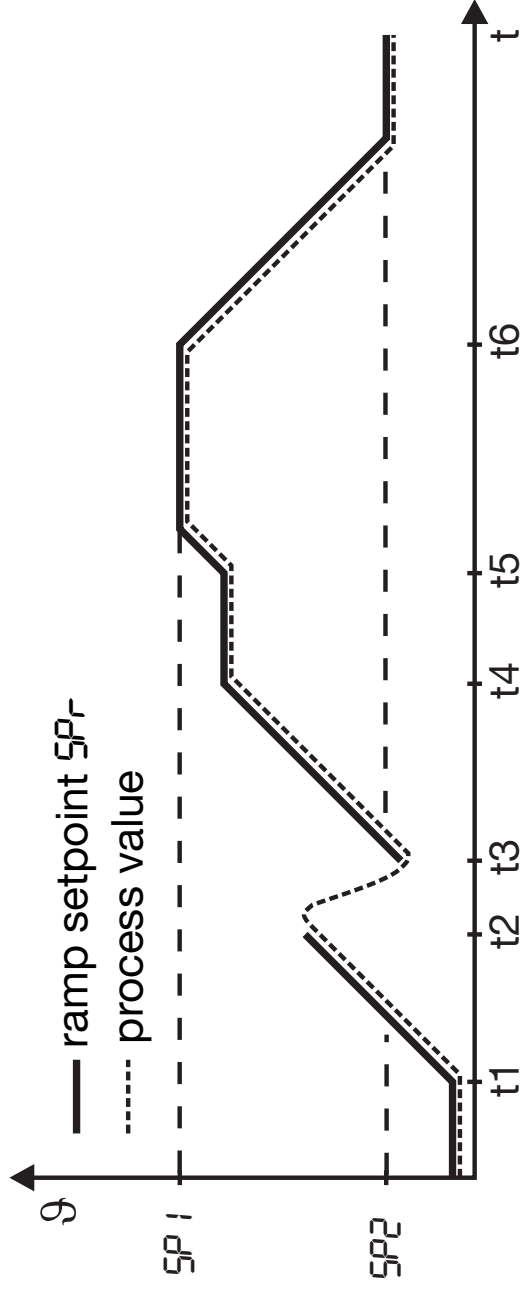

- t1 power ON (SP_i active)
- t2 – t3 power failure or overrange/underrange
- t4 – t5 ramp stop
- t6 setpoint switching to SP_{i+1}

Symbol	Note
C115	Ramp function (on/off, time unit) ⇨ page 32
C117	Ramp stop via logic input (floating contact) ⇨ page 33
rASd	Ramp slope in °C/h or °C/min ⇨ page 36

5.6 Self-optimization

Self-optimization determines the optimum controller parameters for PID or PI controllers.

The following controller parameters are defined: r_t , d_t , P_b , i , P_b , z , C_y , i , C_y , z , d_f

The controller selects procedure **a** or **b**, depending on the size of the control deviation:

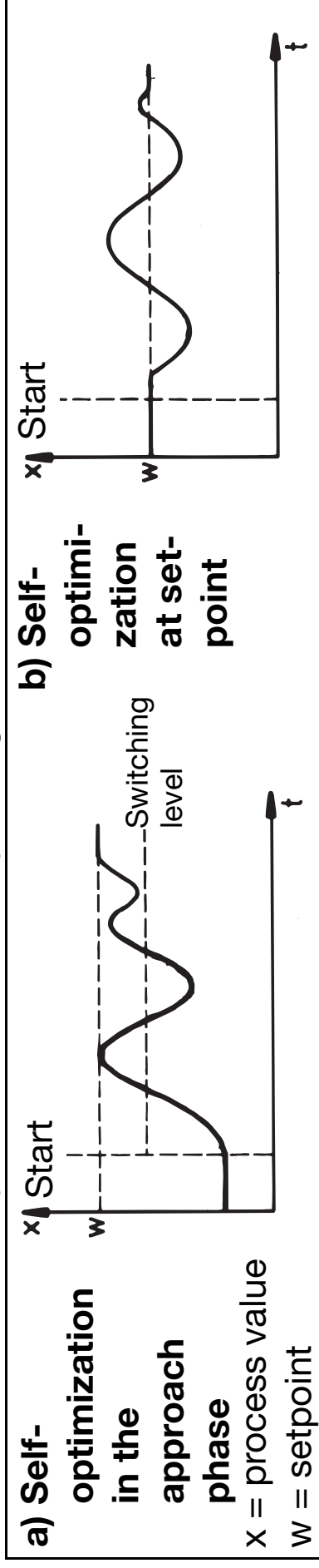

Starting self-optimization

Starting self-optimization is not possible with active level inhibit and ramp function.



Self-optimization is automatically terminated, or can be cancelled.

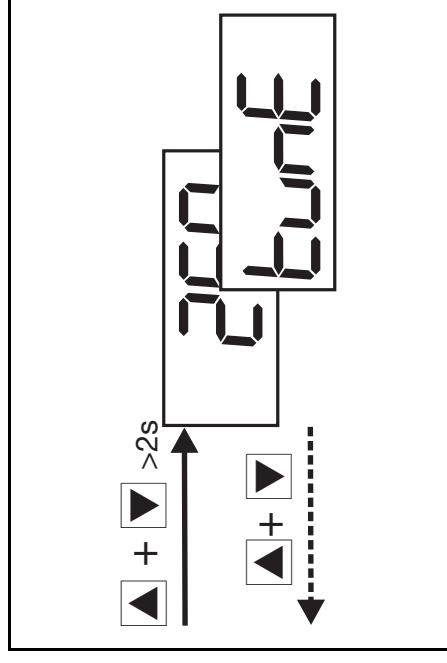

5.7 Level inhibit via code

As an alternative to the logic input, the level inhibit can be set via a code (logic input has priority).

- * Set the code using **P** + **▼** (at least 5sec) in normal display

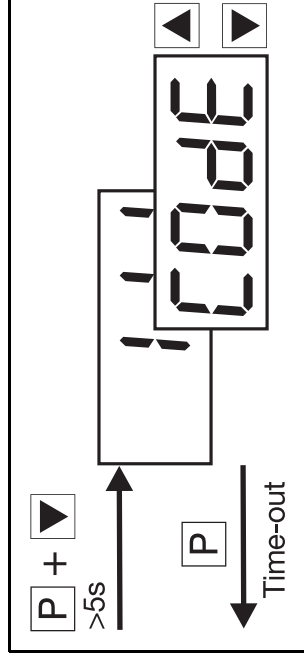

Level inhibit via the logic input will lock the parameter and configuration levels (corresponds to code 011).

Code	Operating level	Parameter level	Configuration level	Timer level
000	enabled	enabled	enabled	enabled
001	enabled	enabled	inhibited	enabled
011	enabled	inhibited	inhibited	enabled
111	inhibited ¹	inhibited	inhibited	inhibited ²

1. The values at the operating level can only be indicated but not modified.
2. Timer operation (start/stop/continue/cancel) will continue to be possible.

5.8 Timer function (extra code)

Using the timer function, the control action can be influenced by means of the adjustable time t, \bar{t} . After the timer has been started by power ON, by pressing the key, or via the logic input, the timer start value t, \bar{t} is counted down to 0, either instantly or after the process value has gone above or below a programmable tolerance limit. When the timer has run down, several events are triggered, such as control switch-off (output 0%) and setpoint switching. Furthermore, it is possible to implement timer signalling via an output.

Example:

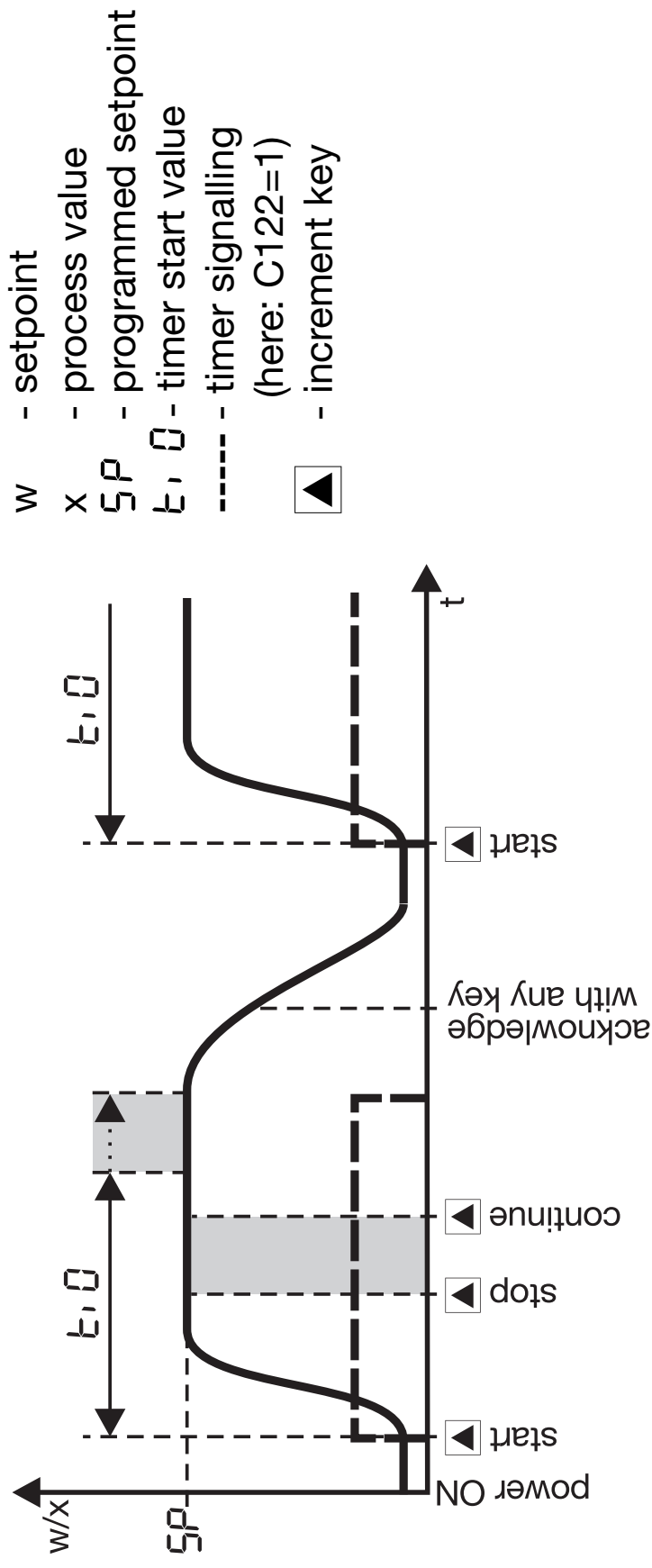

Notes on the timer function in conjunction with the ramp function

- Generally, the setpoints can also be approached using the ramp function.
- Stopping the timer does not influence the ramp function.
- If control is active after the timer has run down, the current setpoint is approached with the ramp. Cancellation of the timer is followed by a setpoint step without ramp.
- For timer functions with a tolerance limit, only the setpoint (=ramp end value) is monitored.

Note on setpoint switching via the logic input

- Setpoint switching via the logic input is generally possible. An exception here is the timer function “Time-dependent setpoint switching”. In this case, configured setpoint switching via the logic input will not be active.

Note on the display status in the event of a power failure

- The state of the display before the power failure will be restored, except for events that are related to the timer (start, cancel, continue, stop). Then the timer value will be shown in the display.

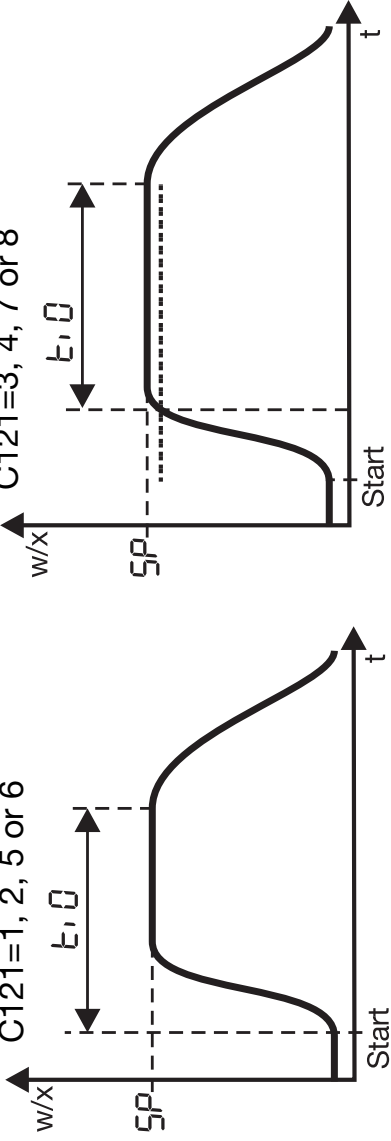
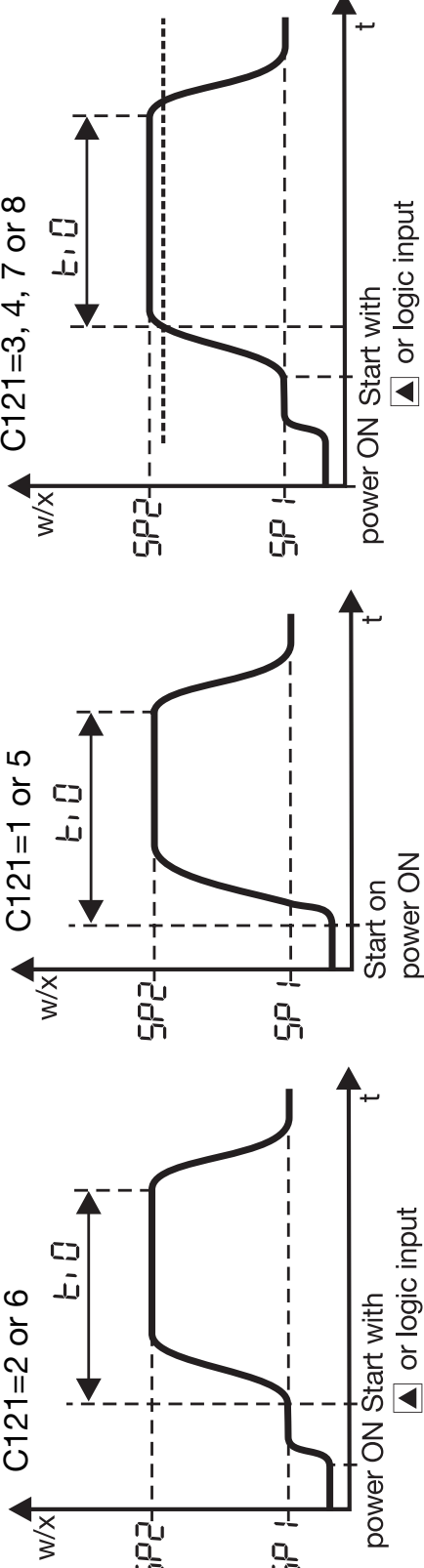
Symbol	Notes
<p>C 120 C120=1</p>	<p>Timer function ⇨ page 34</p> <p>Time-limited control: The control is switched off after the timer has run down (output 0%)</p>  <p>Diagrams with and without start above tolerance limit.</p> <p>----- Tolerance limit</p>
<p>C120=2</p>	<p>Time-dependent setpoint switching: After the start of the timer function, the process is controlled to setpoint SP_2. After the timer has run down, the controller automatically switches over to SP_1.</p>  <p>power ON Start with <input type="checkbox"/> or logic input</p>

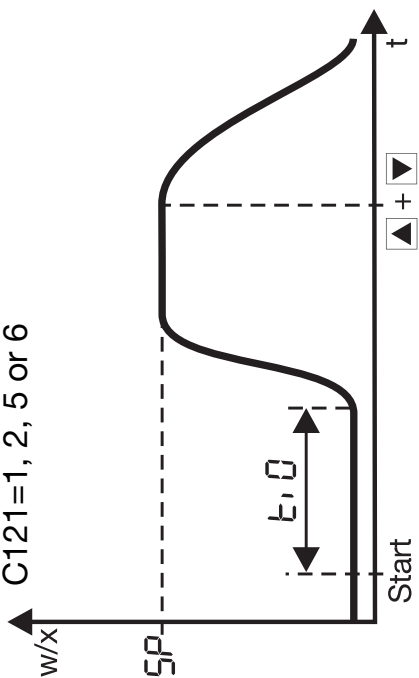
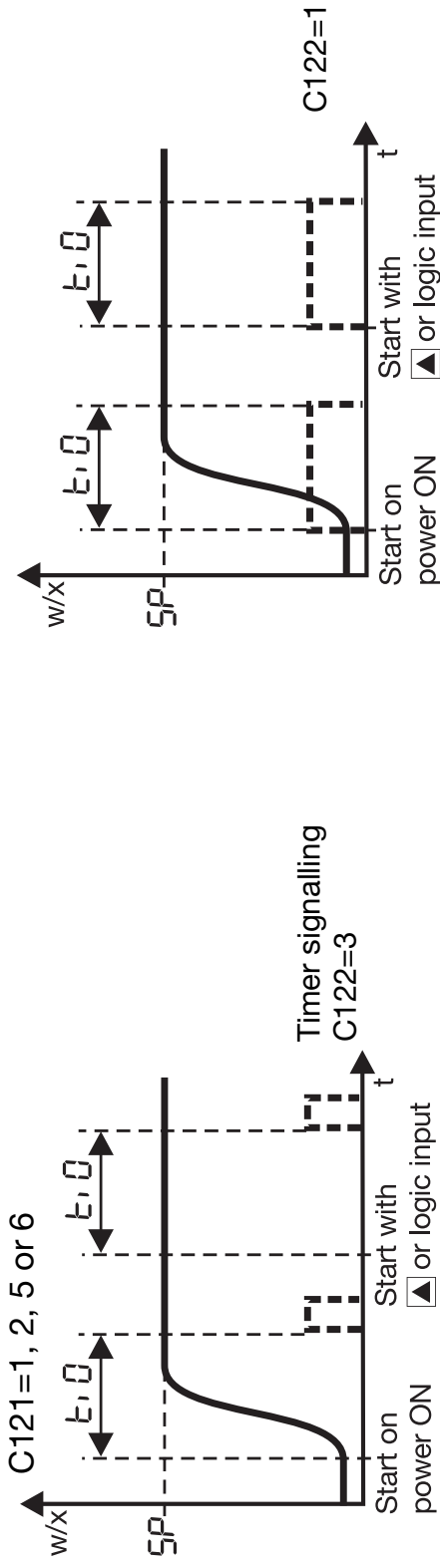
Symbol	Notes
<p>C120</p> <p>C120=3</p>	<p>Time-delayed control: The control action starts after the timer has run down.</p>  <p>C121=1, 2, 5 or 6</p> <p>After the timer has run down (t_{end}), the $\blacktriangle + \blacktriangleright$ keys are used for acknowledgment. Set $t_{\text{end}} > 0\text{ s}$</p>
<p>C120=4</p>	<p>Timer: After the start of the timer function, t_{end} is counted down to 0. The control action is independent of the timer. Here, too, the timer run-down can be signalled via an output.</p>  <p>C121=1, 2, 5 or 6</p> <p>C122=1</p> <p>C122=3</p>

Symbol	Notes
C 121	<p>Start condition of the timer ⇨ page 34 The timer start value t_{start} is counted down as selected in the following events:</p> <ol style="list-style-type: none"> 1. Power ON or logic input/keys 2. Start via keys/logic input 3. Process value has reached tolerance limit (1 °C or 5 °C) (start via keys/logic input) <p>The position of the tolerance limit depends on the controller type:</p> <ul style="list-style-type: none"> - 1-setpoint controller (direct): tolerance limit above setpoint - 1-setpoint controller (reversed): tolerance limit below setpoint - 2-setpoint controller: tolerance limit below setpoint <p>If, during the control process, the process value goes above/below the tolerance limit, the timer will be stopped for the duration of the infringement.</p> 
C 122	<p>Response to a power failure ⇨ page 34 After a power failure, the condition before the power failure can be restored, or the timer function can be cancelled. If the timer had run down before the power failure, the timer start value will be loaded. The timer will start automatically when C121=1 or 5. The timer value is saved at one minute intervals, to cover the case of a power failure.</p>
C 123	<p>Timer signalling ⇨ page 35 From the start of the timer function until timer run-down, or after the run-down, a signal can be produced via an output.</p> <p>Time unit for the timer ⇨ page 35</p>

Programming example

After the start via the logic input or from the keys, the process has to be controlled for 30 minutes to a setpoint of 80 °C. The control action is to be cancelled in the event of a power failure.

Configuration:



- C111 — C116: Controller programming
- C117=5: Logic input = timer control
- C120=1: Timer function = time-limited control
- C121=6: Start condition for timer = via logic input/keys - cancellation on power failure
- C122=0: Timer signalling = no function
- C123=1: Time unit (timer) = mm.ss

Operation:

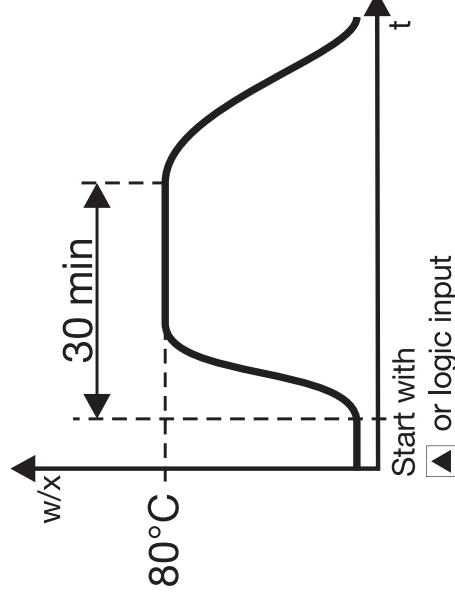
- * Enter the setpoint 5P (80 °C)
- * Press the key until t, is indicated
- * Change over to the timer level using (at least 2 sec)
- * Enter the timer start value t, _ (30.00)
- * Return to the operating level (timer value) with
- * Start the control action via the logic input or with



6 Configuration and parameter tables

<input type="text" value="001"/>	Transducer	<input type="text" value="0"/>	Decimal places/unit	<input checked="" type="checkbox"/>
<input type="text" value="006"/>	Pt 100 (3-wire)	<input checked="" type="checkbox"/>	9999/°C	<input checked="" type="checkbox"/>
<input type="text" value="601"/>	Pt 1000 (3-wire)	<input type="checkbox"/>	999.9/°C	<input type="checkbox"/>
<input type="text" value="003"/>	KTY11-6 (2-wire)	<input type="checkbox"/>	99.99/°C	<input type="checkbox"/>
<input type="text" value="005"/>	Pt 100 (2-wire)	<input type="checkbox"/>	9999/°F	<input type="checkbox"/>
<input type="text" value="039"/>	Pt 1000 (2-wire)	<input type="checkbox"/>	999.9/°F	<input type="checkbox"/>
<input type="text" value="040"/>	Cu-Con T	<input type="checkbox"/>	99.99/°F	<input type="checkbox"/>
<input type="text" value="041"/>	Fe-Con J	<input type="checkbox"/>		<input type="checkbox"/>
<input type="text" value="042"/>	Cu-Con U	<input type="checkbox"/>		<input type="checkbox"/>
<input type="text" value="043"/>	Fe-Con L	<input type="checkbox"/>		<input type="checkbox"/>
<input type="text" value="044"/>	NiCr-Ni K	<input type="checkbox"/>		<input type="checkbox"/>
<input type="text" value="045"/>	Pt10Rh-Pt S	<input type="checkbox"/>		<input type="checkbox"/>
<input type="text" value="046"/>	Pt13Rh-Pt R	<input type="checkbox"/>		<input type="checkbox"/>
<input type="text" value="048"/>	Pt30Rh-Pt B	<input type="checkbox"/>		<input type="checkbox"/>
<input type="text" value="052"/>	NiCrSi-NiSi N	<input type="checkbox"/>		<input type="checkbox"/>
<input type="text" value="053"/>	Standard signal 0 – 20mA	<input type="checkbox"/>		<input type="checkbox"/>
<input type="text" value="063"/>	Standard signal 4 – 20mA	<input type="checkbox"/>		<input type="checkbox"/>
<input type="text" value="071"/>	Standard signal 0 – 10V ²	<input type="checkbox"/>		<input type="checkbox"/>
	Standard signal 2 – 10V ³	<input type="checkbox"/>		<input type="checkbox"/>

 Mark your selection with a cross.

**Normal display/
Operating level**

1. 5P . i, fL or fLb . i is shown here, depending on the configuration
2. 0 – 1 V for Type 702040/41 with 2 relay outputs (option)
3. 0.2 – 1 V for Type 702040/41 with 2 relay outputs (option)

C113	Controller type	Output 1 (relay)	Output 2+3 (logic+relay)	X
10	single setpoint (reversed)	controller	LK/timer signalling ¹	
11	single setpoint (direct)	controller	LK/timer signalling ¹	
30	double setpoint	controller output 1	controller output 2	
20	single setpoint (reversed)	LK/timer signalling ¹	controller	
21	single setpoint (direct)	LK/timer signalling ¹	controller	
33	double setpoint	controller output 2	controller output 1	

1. A programmed limit comparator (LK) has priority over the timer signalling.

Further settings for the outputs with Type 702042/43/44, see C118.

C114	Limit comparator (LK)	X	C115	Ramp function	X
0	no function		0	ramp function off	
1	lk 1		1	ramp function (°C/min)	
2	lk 2		2	ramp function (°C/h)	
3	lk 3				
4	lk 4				
5	lk 5				
6	lk 6				
7	lk 7				
8	lk 8				



...

reversed = heating (output is active when process value is below setpoint) = controller output 1
 direct = cooling (output is active when process value is above setpoint) = controller output 2

¶ 116	Outputs on fault	X	¶ 117	Logic input	X
0	0% ¹	LK/timer signalling OFF	0	no function	 no function key inhibit level inhibit ramp stop setpoint switching timer control
1	100% ²		1	key inhibit	
2	-100% ¹	2	level inhibit		
3	0% ¹	3	ramp stop		
4	100% ²	4	setpoint switching		
		5	timer control		

1. Minimum output limiting H₂ is effective
 2. Maximum output limiting H₁ is effective

¶ 118	Output 1: Relay (K1)	Output 2: Logic (K2)	Output 3: Relay	X
0	Functions of outputs as defined under ¶ 113			
1	controller output	limit comparator	timer signalling	
2	controller output	timer signalling	limit comparator	
3	limit comparator	controller output	timer signalling	
4	limit comparator	timer signalling	controller output	
5	timer signalling	controller output	limit comparator	
6	timer signalling	limit comparator	controller output	
7	controller output 1	controller output 2	limit comparator/timer	
8	controller output 1	limit comparator/timer	controller output 2	
9	controller output 2	controller output 1	limit comparator/timer	
10	controller output 2	limit comparator/timer	controller output 1	
11	limit comparator/timer	controller output 1	controller output 2	
12	limit comparator/timer	controller output 2	controller output 1	

C120	Timer function	X
0	no function	
1	time-limited control	
2	time-dependent setpoint switching	
3	time-delayed control	
4	timer (control independent of timer)	

P

C121	Start condition for timer	Action on power failure	X
1	after power ON, logic input/keys	Condition as before the power failure	
2	via logic input/keys		
3	via logic input/keys; timer counts 1°C from tolerance limit		
4	via logic input/keys; timer counts 5°C from tolerance limit		
5	after power ON, logic input/keys	Cancellation of timer function (STOP appears in the display)	
6	via logic input/keys		
7	via logic input/keys; timer counts 1°C from tolerance limit		
8	via logic input/keys; timer counts 5°C from tolerance limit		

The start conditions with tolerance limit (C121=3, 4, 7, 8) are not valid for C120=3 or 4. If C120 is altered, the validity of C121 must be checked.

C 122	Timer signalling	X
0	no function	
1	timer start until run-down after run-down for 10 sec	
2	after run-down for 1min.	
3	after run-down until acknowledgement	
4		

One output has to be configured correspondingly(C113/C118).

C 123	Unit of time (timer)	X
1	mm.ss (max. 99.59)	
2	hh.mm (max. 99.59)	
3	hhh.h (max. 999.9)	

s = seconds; m = minutes;
h = hours

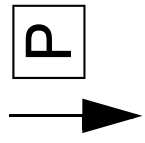

Parameter	Explanation	Value range	factory-set	Your setting
SCL	start value of the standard signal	-1999 to +9999 digit	0	
SCH	end value of the standard signal	-1999 to +9999 digit	100	
SPL	lower setpoint limiting	-1999 to +9999 digit	-200	
SPH	upper setpoint limiting	-1999 to +9999 digit	850	
OFF5	process value correction	-1999 to 9999 digit ¹	0	
HYS5	switching differential of the limit comparator	0 – 9999 digit ¹	1	

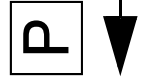

1. For displays with one or two decimal places, the value range and the factory setting change accordingly.
Example: 1 decimal place → value range: -199.9 to +999.9



Parameter	Explanation	Value range	factory-set	Your setting
SP 1	setpoint 1	SPL – SPH	0	
SP 2	setpoint 2	SPL – SPH	0	
AL	limit value of limit comparator	-1999 to +9999 digit	0	
Pb .1	proportional band 1	0 – 9999 digit ¹	0	
Pb .2	proportional band 2	0 – 9999 digit ¹	0	
dt	derivative time	0 – 9999 sec	80 sec	
rt	reset time	0 – 9999 sec	350 sec	
CY 1	cycle time 1	1.0 – 999.9 sec	20.0 sec	
CY 2	cycle time 2	1.0 – 999.9 sec	20.0 sec	
db	contact spacing	0 – 1000 digit ¹	0	
HYS.1	differential 1	0 – 9999 digit ¹	1	
HYS.2	differential 2	0 – 9999 digit ¹	1	
Y .0	working point	-100 to 100 %	0 %	
Y .1	maximum output	0 – 100 %	100 %	
Y .2	minimum output	-100 to +100 %	-100 %	
dF	filter time constant	0.0 – 100.0 sec	0.6 sec	
rASd	ramp slope	0 – 999 °C/h (°C/min) ¹	0	

1. For displays with one or two decimal places, the value range and the factory setting change accordingly.

7 Alarm messages

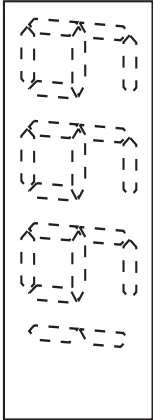
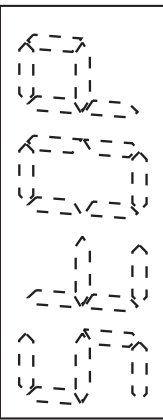
Display	Description	Cause/response
	<p>The displays for the process value or timer value flashes "1999". Display current timer value by repeatedly pressing the P key.</p>	<p>Over/underrange of process value. Controller and limit comparators referred to the process value input behave in accordance with the configuration of the outputs. The timer is stopped.</p>
	<p>The display for the timer value alternates between showing "STOP" and the time. * Acknowledge by using any key, (the timer start value t, 0 is loaded)</p>	<p>The timer function has been cancelled due to a supply failure. The timer value that was present at the time of the supply failure will be indicated.</p>



The following events come under the heading over/underrange:

- Probe break/short-circuit
- Measurement is outside the control range of the probe that is connected
- Display overflow

Measurement circuit monitoring (• = recognized)

Transducer	Ovrange/ underrange	Probe/ lead short-circuit	Probe/lead break
Thermocouple	•	-	•
Resistance thermometer	•	•	•
Voltage	• •	• -	• -
Current	• •	• -	• -

8 Technical data

Input for thermocouple

Designation	Range
Fe-Con L	-200 to + 900 °C
Fe-Con J	-200 to +1200 °C
Cu-Con U	-200 to + 600 °C
Cu-Con T	-200 to + 400 °C
NiCr-Ni K	-200 to +1372 °C
NiCrSi-NiSi N	-200 to +1300 °C
Pt10Rh-Pt S	0 – 1768 °C
Pt13Rh-Pt R	0 – 1768 °C
Pt30Rh-Pt6Rh B	0 – 1820 °C ¹
Measurement accuracy: ≤0.4% / 100ppm/°C	
Cold junction: Pt100 internal	

1. Accuracy is assured within the range 300 – 1820 °C

Input for standard signals

Designation	Range
Voltage	0 – 10V, $R_E > 100k\Omega^2$ 2 – 10V, $R_E > 100k\Omega^3$ R_E - input resistance
Current	4 – 20mA, voltage drop ≤ 1,5V 0 – 20mA, voltage drop ≤ 1,5V
Measurement accuracy: ≤0.1% / 100ppm/°C	

- 0 – 1V, $R_E > 10M\Omega$ for Type 702040/41 with 2 relays
- 0.2 – 1V, $R_E > 10M\Omega$ for Type 702040/41 with 2 relays

Input for resistance thermometer

Designation	Range
Pt100 EN 60751	-200 to +850 °C
Pt1000 EN 60751	-200 to +850 °C
KTY11-6	-50 to +150 °C
Measurement accuracy: Pt100/1000: ≤0.1% / 50ppm/°C KTY11-6: ≤1.0% / 50ppm/°C	
Sensor lead resistance: 20Ω max. per lead	
Meas. current: 250μA	

Outputs

Relay:

n.o.(make) contact; 3A at 250V AC resistive load;
150,000 operations at rated load

Logic 0/5 V:

Current limiting: 20 mA; $R_{load} \geq 250\Omega$

Logic 0/12 V:

Current limiting: 20 mA; $R_{load} \geq 600\Omega$

Supply

- 110 – 240V AC -15/+10% 48 – 63Hz, or
- 20 – 53V AC/DC 48 – 63Hz, or
- 10 – 18V DC (Connect to SELV or PELV)

Controller

Controller type	1-setpt. controller with limit comparator, 2-setpt. controller
Controller structure	P/PD/PI/PID
A/D converter	resolution >15 bit
Sampling time	210msec (250msec with timer function)

Accuracy of timer: 0.7% / 10ppm/°C

Test voltages (type test)

to EN 61 010, Part 1, March 1994, overvoltage category II, pollution degree 2, for Type 702040/41
overvoltage category III, pollution degree 2, for Type 702042/43/44

Power consumption: 5VA max.

Electrical connection

at the rear via plug-in screw terminals, conductor cross-section $\leq 2.5\text{mm}^2$ (1.3mm² with Type 702040/41) solid wire or 1.5mm² (1.0mm² for Type 702040/41) stranded wire with ferrules

Electromagnetic compatibility

EN 61 326
Immunity to interference: Class B
Interference emission: industrial requirements

Data backup: EEPROM

Housing type

plastic housing for panel mounting to DIN 43700

Cleaning the front panel

use warm or hot water (add mildly acidic, neutral or mildly alkaline detergents, if necessary). Do not use any abrasive cleaning agents or high-pressure cleaners. Limited resistance to organic solvents (e. g. spirits, benzol, etc.).

Housing mounting

in panel to DIN 43 834

Ambient and storage temperature

0 to 55°C / -40 to +70°C

Climatic conditions

$\leq 75\%$ rel. humidity, no condensation

Operating position: any

Weight (approx.)

75g (702040)	160g (702043)
95g (702041)	200g (702044)
145g (702042)	

Protection

IP66 (front) to EN 60529
IP20 (rear)

Safety regulation: to EN 61010



JUMO GmbH & Co. KG

Street address:
Moltkestraße 13 - 31
36039 Fulda, Germany
Delivery address:
Mackenrodtstraße 14
36039 Fulda, Germany
Postal address:
36035 Fulda, Germany
Phone: +49 661 6003-0
Fax: +49 661 6003-607
e-mail: mail@jumo.net
Internet: www.jumo.net

JUMO Instrument Co. Ltd.

JUMO House
Temple Bank, Riverway
Harlow, Essex CM20 2TT, UK
Phone: +44 1279 635533
Fax: +44 1279 635262
e-mail: sales@jumo.co.uk
Internet: www.jumo.co.uk

JUMO PROCESS CONTROL INC.

885 Fox Chase, Suite 103
Coatesville PA 19320, USA
Phone: 610-380-8002
1-800-554-JUMO
Fax: 610-380-8009
e-mail: info@JumoUSA.com
Internet: www.JumoUSA.com