



THERMAL PROCESS TECHNOLOGY 1

FURNACES AND HEAT TREATMENT PLANTS FOR PROCESSES UNDER AIR



Facts

- Production of Arts & Crafts furnaces, laboratory furnaces, dental furnaces and industrial furnaces since 1947
- Production site in Lilienthal/Bremen - Made in Germany
- 600 employees worldwide
- 150,000 customers in more than 100 countries
- Very wide product range of furnaces
- One of the biggest R&D departments in the furnace industry
- High vertical integration

Global Sales and Service Network

- Manufacturing only in Germany
- Decentralized sales and service close to the customer
- Own sales organization and long term sales partners in all important world markets
- Individual on-site customer service and consultation
- Fast remote maintenance options for complex furnaces
- Reference customers with similar furnaces or systems close to you
- Secured spare parts supply, many spare parts available from stock
- Further information see page 98

Setting Standards in Quality and Reliability

- Project planning and construction of tailor-made thermal process plants incl. material handling and charging systems
- Innovative controls and automation technology, adapted to customer needs
- Very reliable and durable furnace systems
- Customer test center for process assurance

Experience in Thermal Processing

- Thermal Process Technology
- Additive Manufacturing
- Advanced Materials
- Fiber Optics/Glass
- Foundry
- Laboratory
- Dental
- Arts & Crafts

Table of Contents



Processes

- Furnaces and accessories for heat treatment in air 4
- Heat treatment of metals under protective
or reactive gases or in vacuum 6
- Which furnace for which process? 8
- Plastics 9
- Additive manufacturing 10

Heating Cabinets, Ovens and Chamber Ovens up to 300 °C

- Heating cabinets 14
- Ovens 16
- Chamber ovens 18

Furnaces and Ovens with Safety Technology EN 1539

- Forced convection chamber furnaces up to 500 liter 25
- Forced convection chamber furnaces from 1000 liter 26
- Ovens 27
- Chamber ovens 28

Forced Convection Furnaces up to 850 °C

- Forced convection chamber furnaces – tabletop design 32
- Forced convection chamber furnaces up to 675 liter 34
- Forced convection chamber furnaces from 1000 liter 36
- Forced convection pit-type furnaces 40
- Pit-type and top-loading furnaces with or without air circulation 42
- Drawer furnaces 43
- Forced convection bogie hearth furnaces 44

Chamber Furnaces, Bogie Hearth Furnaces and Top Hat Furnaces up to 1400 °C

- Chamber furnaces, electrically heated 48
- Chamber furnaces, sheet metal preheating furnaces 50
- Bogie hearth furnaces 52
- Gas-fired bogie hearth furnaces up to 1400 °C 54

- Chamber furnaces, gas-fired 55
- Top hat furnaces or bottom loading furnaces with wire heating
up to 1400 °C 56

Furnaces for Continuous Processes

- Rotary hearth furnaces up to 1300 °C
with and without air circulation 60
- Continuous furnaces 62
- Wire and strand annealing furnaces 65

Tempering Plants for Aluminum and Steel

- Tempering plants 68
- Drop-bottom furnaces/vertical tempering plants 69
- Customized solutions 72
- Horizontal tempering plants 74
- More tempering plant concepts 76
- Quench tanks 77

Furnaces for Special Applications

- Clean room solutions 80
- Energy efficiency concepts 81

Process Control and Documentation

- Nabertherm controller series 500 84
- MyNabertherm app for mobile monitoring of process progress 86
- Functions of the standard controllers 88
- Process data storage and data input via PC 89
- Process data storage – VCD-software for visualization,
control and documentation 90
- PLC controls 91
- Process data storage for PLC controls 92
- Nabertherm control center NCC 93
- Temperature uniformity and system accuracy 94
- AMS2750F, NADCAP, CQI-9 95

Furnaces and Accessories for Heat Treatment in Air



Nabertherm offers an extensive range of furnaces with graduated solutions for the heat treatment of materials in air. This catalog clearly presents the different furnace concepts that can be used for the different processes.

Which furnace is suitable for which application?

The furnace type requirements generally depend on the following factors:

- Desired temperature working range
- Charge dimensions
- Required heating and cooling times
- Throughput
- Type of loading respectively degree of automation
- Safety requirements, e.g. when working with charges containing solvents

Depending on the process requirements, customized solutions for the heat treatment including quenching can be offered. The furnaces can be designed either electrically heated or gas-fired.



Chamber oven KTR 3100 DT with rotating system

Ovens and Heating Cabinets

Chamber ovens or heating cabinets are particularly suitable for drying processes, curing processes and also heat treatment processes that take place at low temperatures. Heating cabinets with a capacity of 4500 liters or more which are operated with a separate heating unit up to 150 °C represent the entry-level price. If flammable substances are released during the drying process, chamber ovens can be used and expanded with a safety system in accordance with EN 1539.

Forced Convection Chamber Furnaces up to 850 °C

Forced convection chamber furnaces are used for processes that take place below 850 °C. This furnace family convinces with a very good temperature uniformity due to the powerful air circulation. Convection chamber furnaces are particularly suitable for high normative requirements, such as the AMS2750F. A wide range of standard sizes, the modular structure and the choice between three different maximum working temperatures enable an individual configuration tailored to the process.

Chamber Furnaces with Radiant Heating

Chamber furnaces with radiant heating are ideally suited for use in tool making and in the hardening shop for processes such as annealing, hardening or forging thanks to their robust design. For heat treatment processes that require short heating times and thus a high heating output, the furnaces can be designed with gas firing.



Forced convection chamber furnace NA 250/45



Chamber furnace N 41/H with radiant heating

Bogie Hearth Furnaces with Radiant Heating or Forces Air-Circulation



Bogie hearth furnace W 3900/85AS

Bogie hearth furnaces are used for high charge weights. The bogie hearth can be loaded outside the furnace using a crane or forklift. The electric car drive enables the bogie to be moved easily. By using several bogies, the furnace system can also be designed for an automatic bogie exchange.

Depending on the application temperature and purpose, these furnaces are available as forced convection bogie hearth furnaces up to 850 °C, and above this temperature as radiant ovens. All models can be electrically or gas-fired. With the gas furnace can be designed with direct or indirect heating. Indirect heating is recommended if the charge is sensitive to combustion gases.

Top Hat Furnaces

In practice, top hat furnaces or bottom loading furnaces offer the advantage that they can be freely charged from different sides. The basic furnace is equipped with a fixed table under the hood. The system can be expanded with one or more changing tables, which are driven by hand or motor. Automatic table changes can also be easily implemented with this technology.



Forced convection pit-type furnace SAH 1780/60S

Pit-Type and Top-Loading Furnaces

Pit-Type and Top-Loading Furnaces are very suitable for the heat treatment of long or heavy components. In most cases, charging is carried out with an indoor crane. Thanks to their powerful air circulation, the furnaces with a maximum temperature of up to 850 °C achieve a very good temperature uniformity. The radiation-heated top-loading furnace for the temperature range up to 1280 °C also achieve very good temperature uniformity in the upper temperature range due to their five-sided heating.

Furnaces for Continuous Processes

Continuous furnaces are the right choice for continuous processes with fixed cycle times such as drying, pre-heating, curing, aging, vulcanizing, or tempering. The furnace design depends on the required throughput, the process requirements for the heat treatment such as the process temperature and the required cycle time.

Quench and Temper Plants

Quench and temper plants are used, for example, for the solution annealing and subsequent rapid quenching of aluminum alloys. In the case of thin-walled aluminum components in particular, quenching delay times of just 5 seconds from the beginning of the door opening to complete immersion of the charge in the quenching bath must be sometimes implemented. These strict requirements can usually only be achieved with a chute furnace. Furnace concepts with manipulators and for higher working temperatures, e.g. for tempering steel, can also be realized.



Drop-bottom furnace plant for aluminum

Heat Treatment of Metals under Protective or Reactive Gases or in Vacuum

A large number of heat treatments of metals are usually carried under protective or reaction gases or in vacuum to prevent or minimize oxidation of the components.



Nabertherm offers an extensive range of graduated solutions for the heat treatment of metals. The catalog "Thermal Process Technology 2, furnaces and heat treatment plants for processes under protective or reactive gases or in vacuum", provides a description of the different furnace concepts and the accessories that are available for the different processes.



Forced convection chamber furnace
NA 120/65 I

Sealed Furnace

Sealed furnaces are standard furnaces with a protective gas connection in which the housing is sealed and the door design is adapted. These furnaces are suitable for processes without high requirements with respect to residual oxygen, or for heat treatment of components that are to be processed afterwards.



Forced convection chamber furnace
N 250/85 HA with protective gas box

Furnaces with Protective Gas Boxes, Protective Gas Boxes with an Evacuation Lid or Annealing Bags

Heat treatment furnaces with protective gas boxes or annealing bags offer a good price/performance ratio and can be used for many processes that have to be carried out in a non-flammable protective or reaction gas atmosphere.

By using a protective gas box with the corresponding process gas supply, a standard furnace can be upgraded to a protective gas furnace. Depending on the type of process gas, the preflushing rate, the process flushing rate, and the condition of the box, it is possible to achieve residual oxygen concentrations in the low ppm range.

Depending on the application, the protective gas boxes are removable, remain in the furnace, or are especially designed for heat treatment of bulk materials. Annealing bags are another gassing variant.

For charges with complex shapes or drilled holes, bulk materials, or sensitive materials, such as titanium, it is recommended to use a protective gas box with an additional evacuation lid for cold stage evacuation.

Protective gas boxes can be used in forced convection furnaces at temperatures up to 850 °C and in radiation heated furnaces for working temperatures up to 1100 °C.



Retort furnace NR 80/11

Hot-Wall Retort Furnaces

Retort furnaces are the perfect solution if the process requires a furnace chamber with a pure atmosphere. The retort is not water cooled and is therefore restricted in maximum temperature. Water cooling is used only for the door seal. Hot-wall retort furnaces can be used for maximum working temperatures of 1100 °C, and with special retort material, up to 1150 °C.

These gas tight retort furnaces are ideal for heat treatment processes that require a defined protective or reaction gas atmosphere. The compact models can also be designed for heat treatment in vacuum up to 600 °C. Equipped with corresponding safety technology, retort furnaces are also suitable for applications under reaction gases such as hydrogen.



Cold-Wall Retort Furnaces

Cold-wall retort furnaces can be used for heat treatment processes in defined protective or reaction gas atmospheres or high temperature processes under vacuum. The VHT retort furnaces are designed as electrically heated chamber furnaces with graphite, molybdenum, tungsten or MoSi₂ heating.

The vacuum-tight retort is completely water-cooled and allows for heat treatment processes either in protective or reaction gas atmospheres or under vacuum up to 5×10^{-6} mbar.

This furnace series can also be equipped with suitable safety packages for flammable gases.



Retort furnace VHT 100/16-MO

Furnaces for Continuous Processes

Nabertherm also has compact furnaces for continuous processes that require a protective or reaction gas atmosphere.



Hydrogen continuous furnace
D 150/1600/20/10 H₂

Martempering and Salt-Bath Furnaces

Martempering and salt-bath furnaces have excellent temperature uniformity and ensure very good heat transfer to the work piece. Generally, heat treatment can be carried out with shorter dwell times than in chamber furnaces. Since the charge is heat treated with the exclusion of oxygen, scale and discoloration on the surface of the parts are reduced considerably.

Martempering furnaces with a maximum working temperature of 550 °C are suitable for processes such as tempering or bainite hardening (intermediate stage hardening). For annealing processes carried out at higher temperatures, salt bath furnaces are used.



Salt-bath furnace TS 30/18 with preheating chamber above the salt bath and charging aid for immersion of the charge

Which Furnace for Which Process?

Furnace group	Model	Curing, Tempering, Drying, Vulcanizing	Tempering, Annealing, Solution, Annealing up to 850 °C	Hardening, Annealing from 850 °C	Preheating for Forging	Tempering, Quenching
Heating Cabinets, Ovens and Chamber Ovens up to 300 °C						
Heating cabinets, page 14	WK	●				
Ovens, page 16	TR	●				
Chamber ovens, page 18	KTR	●	●			
Furnaces and Ovens with Safety Technology EN 1539						
Forced convection chamber furnaces up to to 500 liter, page 25	NA .. LS	●				
Forced convection chamber furnaces from 1000 liter, page 26	NA .. LS	●				
Ovens, page 27	TR .. LS	●				
Chamber ovens, page 28	KTR .. LS	●				
Forced Convection Furnaces up to 850 °C						
Forced convection chamber furnaces – tabletop design, page 32	NAT	●	●			
Forced convection chamber furnaces up to 675 liter, page 34	NA 120/45 - NA 675/85	●	●			
Forced convection chamber furnaces from 1000 liter, page 36	NA > 1000 I, N ..HA	●	●			
Forced convection pit-type furnaces, page 40	SAL, SAH	●	●			
Pit-type and top-loading furnaces, page 42	S	●	●			
Drawer furnaces, page 43	NA	●	●			
Forced convection bogie hearth furnaces, Seite 44	W .. A	●	●			
Chamber Furnaces, Bogie Hearth Furnaces and Top Hat Furnaces up to 1400 °C						
Chamber furnaces, electrically heated, page 48	N ../H ../HR N .. 13			●	●	
Chamber furnaces, sheet metal preheating furnaces, page 50	N 731 - N 2401			●	●	
Bogie hearth furnaces, page 52	WS			●	●	
Gas-fired bogie hearth furnaces, page 54	WB			●	●	
Chamber furnaces, gas-fired, page 55	NB			●	●	
Top hat furnaces or bottom loading furnaces, page 56	H ../LB, H ../LT			●	●	
Furnaces for Continuous Processes						
Rotary hearth furnaces, page 60	DH		●	●	●	
Continuous furnaces, page 62	D		●	●	●	
Tempering Plants for Aluminum and Steel						
Drop-bottom furnaces/vertical tempering plants, page 69	FS					●
Horizontal tempering plants, page 74						●
Quench tanks, page 77	WAB					●
Furnaces for Special Applications						
Clean room solutions, page 80			●			

Plastics



Forced convection chamber furnace N 140000/26AS for curing of composites in vacuum bags incl. pump and necessary connections in the furnace chamber

Tempering, Curing, Vulcanization and Degassing of Plastics, Elastomers, Rubber, Silicone, and Fiber Composite Materials

Many plastics and fiber composite materials must be heat-treated for product improvement or to ensure that they have the required product properties. In most cases, chamber ovens, forced convection chamber furnaces or continuous furnaces are used for the respective process. The following examples outline the processes which these furnaces can perform.

PTFE (polytetrafluoroethylene)

One application is the heat treatment of PTFE. This process can be used to improve the adhesive properties, the mixture hardness or the sliding properties of the coating. In most cases, chamber ovens are used which, depending on the type of plastic, may or may not include safety technology based on EN 1539.

Carbon Composite Materials

These days, carbon composite materials are used in many industries such as automotive, aerospace, wind power, agriculture, etc. Different materials and manufacturing processes require different heat-treatment processes for curing composite materials.

Some of the processes are done in autoclaves. Other materials are heat-treated in chamber ovens or furnaces with air circulation. In this case, the composite materials are frequently evacuated in vacuum bags. For this purpose, the furnace is equipped with suitable connections for the evacuation of the vacuum bags.

Silicone

One reason why silicone is tempered is to reduce the amount of silicone oil in the silicone to a certain percentage, i.e. to drive it out, in order to meet relevant food regulations. During the tempering process the silicone oil is vented out of the furnace chamber by continuous air exchange. To optimize the temperature uniformity in the furnace chamber, the fresh air supply is preheated. Depending on the furnace size, a heat-recovery system with heat exchangers can result in significant energy savings and pay for itself in just a short time.

Parts are prevented from sticking together by keeping them moving in a rotating rack in the oven.



Continuous furnace D 1500/3000/300/14 with mesh belt transport system and subsequent cooling station



Silicone tempering furnace with tightly welded inner box and rotating rack for the charge.



KTR 3100/S for curing of composites in vacuum bags incl. pump and necessary connections in the oven chamber

Additive Manufacturing



Chamber furnace LH 216/12 for stress-relief annealing of metal components in protective gas after 3D printing



Hot-wall retort furnace NR 80/11 for stress-relief annealing of metal components in protective gas or vacuum after 3D printing



Cold-wall retort furnace VHT 8/16 MO for residual debinding and subsequent sintering of metal components after 3D printing

3D printing is becoming increasingly important in many industries – individual components can be created and printed quickly, storage costs are reduced as a result of demand-based production and components can be manufactured lighter as a result of modified designs. These are just a few of the almost infinite possibilities of Additive Manufacturing.

No matter whether you use laser-based printing, binder jetting, FDM, or pellets: we have the right heat treatment solution for every printing process.

Nabertherm is a strong partner for heat treatment furnace solutions for post-processing in 3D printing and has many years of experience in the field of heat treatment of aluminum, plastic, and metal alloys as well as debinding/sintering of ceramic and metal components.

Nabertherm provides standard solutions for stress-relief annealing, tempering or hardening for the most common printer sizes or develop customized solutions for future models.

For more challenging alloys, our hot-wall and cold-wall retort furnaces offer a suitable system and can be tailored modularly to suit every requirements.

Depending on the application, we can provide support for documentation and furnace management with the right design. We have implemented many reliable systems with our customers to fulfill AMS2750F, CQI-9, and FDA requirements.

3D Printing on the Path to Automation

Nabertherm has many years of experience in the area of system automation and offer automatic feed systems for furnaces or systems to pre-heat replacement frames, for example, to make printer even more efficient.

We have many standard solutions to suit different materials and furnace atmosphere requirements.

Annealing furnaces with protective gas boxes offering a very appealing price-performance ratio achieve a residual oxygen value of up to 300 ppm, for example. These furnaces are suitable for simple heat treatment where further surface processing is allowed after stress-relief annealing.

Values of < 10 ppm are achieved in hot-wall retort furnaces. This ensures clean surfaces and minimizes subsequent processing even with complex components, such as inner channels.

Vacuum furnaces that achieve an end vacuum of up to 5×10^{-6} mbar meet the highest atmospheric requirements.

Which System for Which Material?



Forced convection chamber furnace NA 250/45 for stress-relief annealing of aluminum after 3D printing



Hot-wall retort furnace NR 300/09 for stress-relief annealing of metal components in protective gas or vacuum after 3D printing

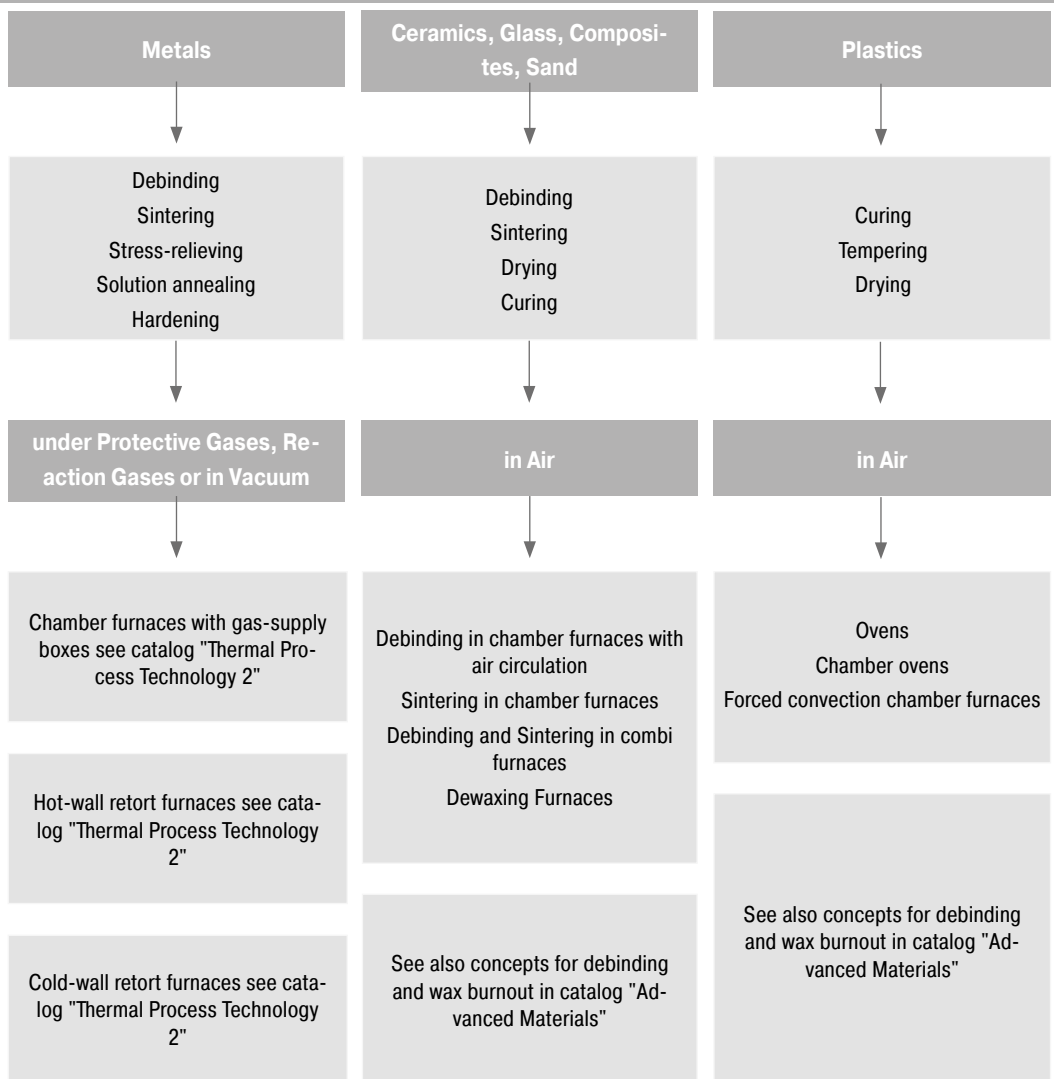

Also, concomitant or upstream processes of additive manufacturing require the use of a furnace in order to achieve the desired product properties, such as heat treatment or drying the powder.

Classification of Print Volume – Furnace Design for Aluminum/Steel/Stainless Steel/Titanium

Print volume in mm			Forced convection furnace	Annealing furnace with protective gas box	Hot-wall retort furnace	Cold-wall retort furnace
w	d	h				
100	100	100	NA 60/..	LH 30/12	N 7/H	VHT 08/..
200	200	200	NA 60/..	LH 60/12	N 41/H	VHT 25/..
300	300	300	NA 120/..	LH 120/12	NR 100/11	VHT 70/..
400	400	400	NA 250/..	LH 216/12	NR 100/11	VHT 250/..
500	500	500	NA 500/..	NW 1000	NR 300/11	VHT 500/..

These are just some examples, other furnace sizes/designs on request



Oven TR 240 to temper plastic



Chamber furnace N 7/H for stress-relief annealing of metal components in protective gas after 3D printing



See also catalog "Additive Manufacturing"

Heating Cabinets, Ovens and Chamber Ovens up to 300 °C

Drying processes or heat treatments at low temperatures benefit from forced air circulation. The results are a better heat transfer and optimization of temperature uniformity. The Nabertherm ovens also impress with an attractive design made of a high-quality stainless steel housing combined with an intuitively operated controller with a colored touch display. The heating cabinets WK are characterized by a very good price-volume ratio and can be used in particular for large batches.

The following equipment applies to all furnaces in this chapter:



Exclusive use of insulation materials without categorization according to EC Regulation No 1272/2008 (CLP). This explicitly means that aluminosilicate wool, also known as “refractory ceramic fiber” (RCF), which is classified and possibly carcinogenic, is not used.



Defined application within the constraints of the operating instructions



Controller with intuitive touch operation



NTLog Basic for Nabertherm controller: recording of process data with USB-flash drive



Freeware NTEdit for convenient program input via Excel™ for Windows™ on the PC



Freeware NTGraph for evaluation and documentation of firings using Excel™ for Windows™ on the PC



MyNabertherm App for online monitoring of the firing on mobile devices for free download



As additional equipment: Process control and documentation via VCD software package for monitoring, documentation and control



Furnace Group	Model	Page
Heating cabinets	WK	14
Ovens	TR	16
Chamber ovens	KTR	18

Heating Cabinets electrically heated

Heating cabinets are ideal for processes in the low temperature range up to max. 150 °C, such as for drying, preheating molds and tools or tempering and curing plastics. They have a compact design and are especially suitable for large charges. They are heated with a separate heating unit that is generally located behind the heating cabinet.



Heating cabinet WK 4500

Standard Equipment

- Tmax 150 °C
- Separate, electric heating unit, consisting of heater register, air circulation system, fresh air inlet and exhaust air outlet
- Powerful, turbulent air flow inside the oven
- Atmosphere exchange via open fresh air inlet and exhaust air outlet
- Temperature uniformity according to DIN 17052-1 up to ± 6 °C see page 94
- Wall structure with 50 mm insulation for a surface temperature $T_{amb.} + 25$ °C, slightly higher near the door. The oven thus complies with ISO 13732-1.
- Floor-level charging without floor insulation
- Over-temperature limiter with adjustable cutout temperature as temperature limiter to protect the furnace and load
- Interior with galvanized steel plate
- Controller with touch operation B500 (5 programs with 4 segments each), controls description see page 84



Heating cabinet WK 12000/S

Additional Equipment

- Steel plate to protect the base against mechanical damage
- Floor insulation, also with drive-in tracks or frame
- Charging trolleys in different designs to allow for charge assembly outside the heating cabinet
- Window in the oven door and interior lighting
- Thermocouple inlets in various sizes
- Cooling system with fan



Two heating cabinets WK 10000/S

Model	Tmax °C	Inner dimensions in mm			Volume in l	Outer dimensions ¹ in mm			Heating power in kW	Connected load* in kW
		b	d	h		W	D	H		
WK 4500	150	1500	1500	2000	4500	1980	3110	2500	18	21
WK 6000	150	1500	2000	2000	6000	1980	3610	2500	18	21
WK 6001	150	2000	1500	2000	6000	2480	3110	2500	18	21
WK 7500	150	2500	1500	2000	7500	2980	3110	2500	27	30
WK 8000	150	2000	2000	2000	8000	2460	3570	2500	27	32
WK 10000	150	2000	2500	2000	10000	2460	4070	2500	45	50
WK 10001	150	2500	2000	2000	10000	2960	3570	2500	45	50
WK 12000	150	2000	3000	2000	12000	2460	4570	2500	45	50
WK 15000	150	2500	3000	2000	15000	2900	4720	2500	54	62
WK 17500	150	2500	3500	2000	17500	2900	5220	2500	54	62

¹External dimensions vary when furnace is equipped with additional equipment. Dimensions on request.

*Please see page 88 for more information about supply voltage



Heating cabinet WK 21600/S with heating unit on the left

Heating register WK 4500

Heating cabinet WK 5100/S with special air flow

Ovens electrically heated

With their maximum working temperature of up to 300 °C and forced air circulation, the ovens achieve a very good temperature uniformity. They can be used for various applications such as e.g. drying, sterilizing or warm storing. Short delivery times from stock are ensured for standard models.



Oven TR 240



Oven TR 450

Standard Equipment

- Tmax 300 °C
- Working temperature range: + 20 °C above room temperature up to 300 °C
- Ovens TR 30 - TR 420 designed as tabletop models
- Ovens TR 450 - TR 1050 designed as floor standing models
- Horizontal forced air circulation results in temperature uniformity according to DIN 17052-1 better than ± 5 °C in the empty work space (with closed exhaust air flap) see page 94
- Stainless steel furnace housing, material no. 1.4016 (DIN)
- Stainless steel chamber, alloy 304 (AISI)/(DIN material no. 1.4301), rust-resistant and easy to clean
- Charging in multiple layers possible using removeable grids (number of removeable grids included, see table to the right)
- Large, wide-opening swing door, hinged on the right with quick release for models TR 30 - TR 240 and TR 450
- Double swing door with quick release for models TR 420, TR 800 and TR 1050
- Ovens TR 800 and TR 1050 equipped with transport castors
- Infinitely adjustable exhaust at the rear wall with operation from the front
- PID microprocessor control with self-diagnosis system
- Controller R7, alternative programmable controllers see page 88
- Solid state relays provide for lownoise operation

Additional Equipment

- Over-temperature limiter with adjustable cutout temperature as temperature limiter to protect the oven and load
- Fan speed of the air circulation fan can be reduced infinitely
- Window for charge observing
- Further removeable grids with rails
- Side inlet
- Electrical rotary device (associated sample holder will be individually adapted to the charge)
- Exhaust air duct DN 80
- Transport castors for models TR 240 - TR 450
- Upgrading available to meet the quality requirements of AMS2750G or FDA
- Fresh-air filter to reduce dust inside the furnace



Oven TR 420



Oven TR 1050 with double door

Model	Tmax in °C	Inner dimensions in mm			Volume in l	Outer dimensions ¹ in mm			Connected load in kW	Electrical connection*	Weight in kg	Minutes to Tmax ²	Grids included	Grids max.	Max. total load ³
		w	d	h		W	D	H							
TR 30	300	360	300	300	30	610	570	670	2.1	1-phase	45	25	1	4	80
TR 60	300	450	390	350	60	700	665	720	3.1	1-phase	90	25	1	4	120
TR 120	300	650	390	500	120	900	665	870	3.1	1-phase	120	45	2	7	150
TR 240	300	750	550	600	240	1000	840	970	3.1	1-phase	165	60	2	8	150
TR 420	300	1300	550	600	420	1550	910	990	6.3	3-phase	250	60	2	8	200
TR 450	300	750	550	1100	450	1000	840	1470	6.3	3-phase	235	60	3	15	180
TR 800	300	1200	680	1000	800	1470	1170	1520	6.3	3-phase	360	80	3	10	250
TR 1050	300	1200	680	1400	1050	1470	1170	1920	9.3	3-phase	450	80	4	14	250

¹External dimensions vary when furnace is equipped with additional equipment. Dimensions on request.

²In the empty and closed oven, connected to 230 V 1/N/PE resp. 400 V 3/N/PE

³Max load per layer 30 kg

*Please see page 88 for more information about supply voltage



Oven TR 30 with observation window



Extricable metal grids to load the oven in different layers



Electrical rotating device (in this case with tailored platform for PARR autoclave containers)

Chamber Ovens electrically heated

The chamber ovens of the KTR range can be used for complex drying processes and heat treatment of charges to an application temperature of 260 °C. The high-performance air circulation enables optimum temperature uniformity throughout the work space. A wide range of accessories allow the chamber ovens to be modified to meet specific process requirements.



Chamber oven KTR 6125



Direct gas-firing at a chamber oven



KTR 4500 with platform bogie, interior lighting and inspection windows

Standard Equipment

- Tmax 260 °C
- Electrically heated (via a heating register with integrated chrome steel heating elements)
- Temperature uniformity up to ± 3 °C according to DIN 17052-1 (for design without track cutouts) see page 94
- High-quality mineral wool insulation provides for outer temperatures of < 25 °C above room temperature
- Incl. floor insulation
- High air exchange for fast drying processes
- Double-wing door for furnaces KTR 2300 and larger
- Over-temperature limiter with adjustable cutout temperature as temperature limiter to protect the oven and load
- Controller with touch operation B500 (5 programs with 4 segments each), controls description see page 84

Additional Equipment

- Direct or indirect gas-fired
- Base frame to charge the oven via a charging forklift
- Additional door in the back for charging from both sides or to use the oven as a lock between two rooms
- Fan system for faster cooling with manual or motor-driven control of the exhaust flaps
- Programmed opening and closing of exhaust air flaps
- Air circulation with speed control, recommendable for processes with light or sensitive charge
- Observation window and furnace chamber lighting
- Design for clean room heat treatment processes
- Rotating systems e. g. for tempering processes
- All KTR-models are also available with Tmax 300 °C



Chamber oven KTR 22500/S with chamber lightning and drive-in tracks with insulated plugs which provide for an optimal temperature uniformity

Accessories

- Adjustable plate shutters to adapt the air guide to the charge and improve temperature uniformity
- Guide-in tracks and shelves
- Shelves with 2/3 extraction with evenly distributed load on the whole shelf surface
- Platform cart in combination with drive-in tracks
- Charging cart with rack system in combination with drive-in tracks
- Sealing shoes for ovens with drive-in tracks to improve temperature uniformity in the work space



Chamber oven KTR 3100/S for curing of composites in vacuum bags incl. pump and necessary connections in the oven chamber



Chamber oven KTR 6125 DTLS for tempering of parts made of silicone. The basket used with the rotation system are also used for the internal transport of the parts.

Here you can watch the product video of the chamber oven for silicone tempering:





Motor-driven rotary rack with baskets for moving the charge during heat treatment



Chamber oven KTR 6250 with double doors in the front and in the back as well as guide-in tracks for use as sluice oven

Model	Tmax °C	Inner dimensions in mm			Volume in l	Outer dimensions ² in mm			Heating power in kW ¹	Electrical connection*
		w	d	h		W	D	H		
KTR 1000	260	1000	1000	1000	1000	1820	1430	1890	18	3-phase
KTR 1500	260	1000	1000	1500	1500	1820	1430	2390	18	3-phase
KTR 2000	260	1100	1500	1200	2000	1920	1930	2090	18	3-phase
KTR 2300	260	1250	1250	1500	2300	2120	1680	2460	27	3-phase
KTR 3100	260	1250	1250	2000	3100	2120	1680	2960	27	3-phase
KTR 3400	260	1500	1500	1500	3400	2370	1930	2460	45	3-phase
KTR 4500	260	1500	1500	2000	4500	2370	1930	2960	45	3-phase
KTR 4600	260	1750	1750	1500	4600	2620	2175	2480	45	3-phase
KTR 6000	260	2000	2000	1500	6000	2870	2430	2460	54	3-phase
KTR 6125	260	1750	1750	2000	6125	2620	2175	2980	45	3-phase
KTR 6250	260	1250	2500	2000	6250	2120	3035	2960	54	3-phase
KTR 8000	260	2000	2000	2000	8000	2870	2430	2960	54	3-phase
KTR 9000	260	1500	3000	2000	9000	2490	3870	2920	72	3-phase
KTR 12300	260	1750	3500	2000	12300	2620	4350	2980	90	3-phase
KTR 13250	260	1250	5000	2000	13250	2120	6170	2960	108	3-phase
KTR 16000	260	2000	4000	2000	16000	2870	4850	2960	108	3-phase
KTR 21300	260	2650	3550	2300	21300	3600	4195	3380	108	3-phase
KTR 22500	260	2000	4500	2500	22500	3140	5400	3500	108	3-phase

¹Depending on furnace design connected load might be higher

²External dimensions vary when furnace is equipped with additional equipment. Dimensions on request.

*Please see page 88 for more information about supply voltage



Adjustable plate shutters to adapt the air guide to the charge

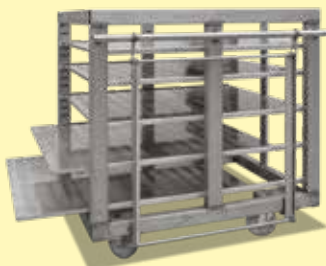

Charging cart with pull-out trays



Pull-out shelves, running on rolls

Furnaces and Ovens with Safety Technology EN 1539

The European standard EN 1539 describes the safety technology design of furnaces and ovens for processes in which solvents or other combustible substances are released and evaporated quickly. The LS version of ovens and forced convection chamber furnaces is specially designed in accordance with these requirements and is equipped with the appropriate safety technology. If the organic components in the process are only slowly evaporated, as is often the case with ceramic processes, we offer further furnaces with alternative safety technology in our Advanced Materials catalog.

The following equipment applies to all furnaces in this chapter:



Exclusive use of insulation materials without categorization according to EC Regulation No 1272/2008 (CLP). This explicitly means that alumino silicate wool, also known as “refractory ceramic fiber” (RCF), which is classified and possibly carcinogenic, is not used.



Defined application within the constraints of the operating instructions



Controller with intuitive touch operation



NTLog Basic for Nabertherm controller: recording of process data with USB-flash drive



Freeware NTEdit for convenient program input via Excel™ for Windows™ on the PC



Freeware NTGraph for evaluation and documentation of firings using Excel™ for Windows™ on the PC



MyNabertherm App for online monitoring of the firing on mobile devices for free download



As additional equipment: Process control and documentation via VCD software package for monitoring, documentation and control



Furnace Group	Model	Page
Forced convection chamber furnaces up to to 500 liter	NA .. LS	25
Forced convection chamber furnaces from 1000 liter	NA .. LS	26
Ovens	TR .. LS	27
Chamber ovens	KTR .. LS	28

Furnaces and Ovens with Safety Technology for charges containing solvents according to EN 1539

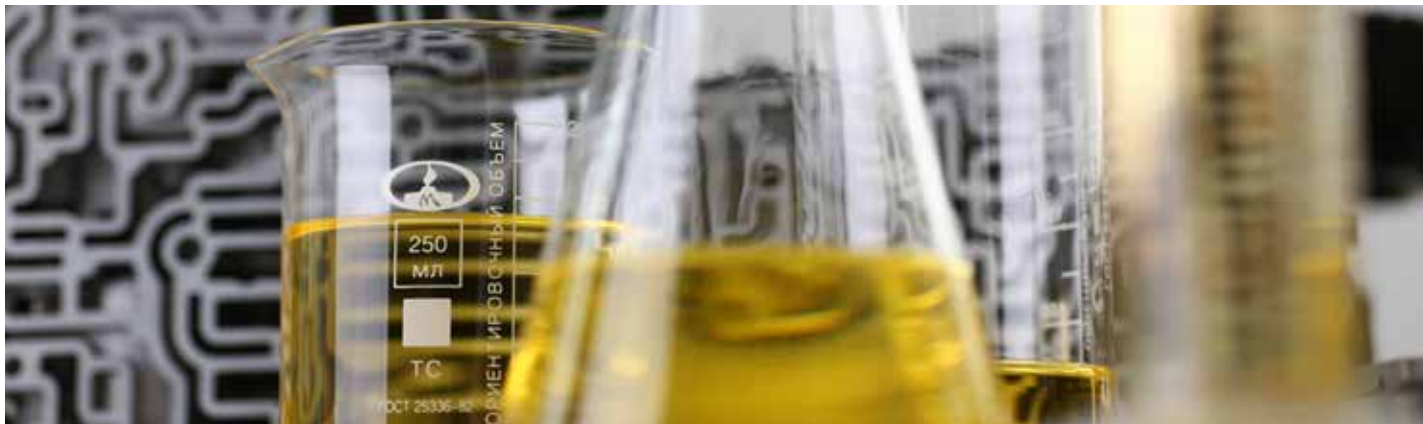

The safety technology of furnaces and ovens used for processes in which solvents or other flammable substances are released and vaporized relatively quickly is regulated throughout Europe in EN 1539. Typical applications are drying of mold varnishes, surface coatings, and impregnating resins. Users include the chemical industry as well as many other areas, such as the automotive, electric, plastics processing and metalworking industries

The safety concept relates to preventing the formation of explosive mixtures through continuous ventilation in the entire vapor space.

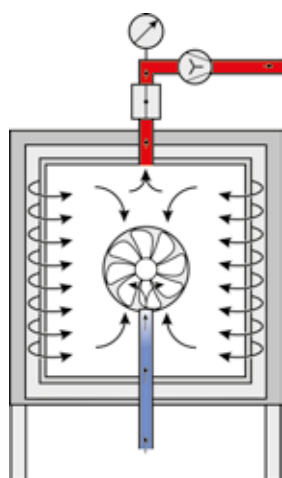

Air



NA 120/45 LS DB with special exhaust gas system

Implementation of the Standard Requirements

An exhaust gas fan ensures continuous ventilation in the oven or furnace. The safety function of the fan is monitored. The vapors occurring during heat treatment are extracted from the furnace chamber with the aid of the exhaust gas fan. The air exchange rate is ensured via a differential pressure system (differential pressure monitoring of the air circulation and the exhaust gas). If the system reports a fault, the furnace goes into malfunction mode and the heating is stopped. Underpressure ensures that the solvent is able to exit the furnace in a controlled manner. The interior of the furnace is completely welded and prevents solvent penetrating and accumulating in the insulation.

Nabertherm specifies the amount of solvent that can be introduced in relation to the working temperature and furnace model. The quantity of solvent is calculated in relation to the worst-case scenario; in other words, rapid evaporation of solvent on the largest possible surface area.

The standard also allows for exceptions where, with lower evaporation rates, larger volumes of solvent per charge may be introduced to the oven. Therefore, customers should always assess the process to comply with the permitted quantity of solvent.

When mold varnishes are being dried, the standard values can be increased by a factor of 10. If the customer's process involves drying impregnating resin (e.g. for transformers, motor windings, etc.), the maximum quantities of flammable materials calculated for rapid evaporation can be increased by a factor of 20. Depending on the process, customers must comply with the current standards.

The high rate of air exchange results in relatively high energy consumption. In EN 1539, it states that, when the main evaporation time has expired, the minimum volumetric flow rate of the exhaust air may be reduced to 25%. According to EN 1539, the main evaporation time is the time in which the main quantity of flammable substances is released. For ovens with safety technology, Nabertherm offers an additional control system to implement this energy saving option. Customers must set and acknowledge the end of the main evaporation time. When this time is reached, the system reduces the volumetric flow rate of the exhaust gas accordingly.

Forced Convection Chamber Furnaces up to 500 Liter with Safety Technology for charges containing solvents according to EN 1539

Due to their very good temperature uniformity, these chamber furnaces with air circulation are especially suitable for processes such as drying paints or components with residues of flammable cleaning agents or the evaporation of solvents bound in the components.



Forced convection chamber furnace NA 120/45 LS

Standard Equipment

- Design based on forced convection chamber furnaces see page 34
- High-powered heating to maintain the required air exchange rates
- Powerful exhaust air fan to ensure underpressure in the furnace
- Defined and monitored air circulation and exhaust air
- Visual and audible malfunction signals
- Over-temperature limiter with manual reset as over-temperature protection for the furnace and the charge
- Controller with touch operation P570 (50 programs with each 40 segments), controls description see page 84

Additional Equipment

- EN 1539 with reduced exhaust air flow rate to 25 % after the main evaporation time to save energy
- EN 1539 with temporary switching off for processes in which no flammable substances are released

Model	Tmax in °C	Inner dimensions in mm			Volume in l	Outer dimensions ¹ in mm			Heating power in kW ²	Exhaust air flow rate in m ³ /h	Maximum volume of solvent in g at temperature:				
		w	d	h		W	D	H			75 °C	150 °C	250 °C	350 °C	450 °C
NA 120/45 LS	450	450	600	450	120	1250	1550	1950	18	100 - 120	51	20	9	5	4
NA 250/45 LS	450	600	750	600	250	1350	1650	2080	24	100 - 120	93	36	17	9	7
NA 500/45 LS	450	750	1000	750	500	1550	1900	2220	24	100 - 120	104	42	21	12	9

¹External dimensions vary when furnace is equipped with additional equipment. Dimensions on request.

²Depending on the furnace design, connected load might be higher



Sluice furnace N 560/26HACLS with safety package, loading from the front and unloading from the back

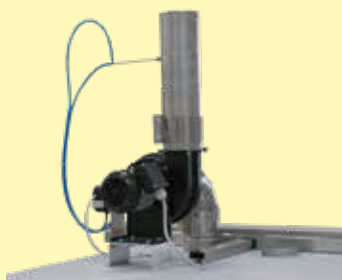

Fresh-air opening and powerful exhaust air fan installed on the furnace



Interior with metal shelf, thermocouples and pressure monitoring

Forced Convection Chamber Furnaces from 1000 Liter with Safety Technology for charges containing solvents according to EN 1539

Models N .. /45 .. are equipped with the corresponding safety technology for drying larger and heavier charges containing solvent. As with the smaller models, the furnaces in this range can be adapted with selected additional equipment to suit the respective charge and process.



Standard Equipment

- Furnace technology based on forced convection chamber furnaces see page 36
- For a description of the safety technology, refer to models NA 120/45 LS ff.
- Over-temperature limiter with manual reset as over-temperature protection for the furnace and the charge
- Controller with touch operation P570 (50 programs with each 40 segments), controls description see page 84

Additional Equipment

- EN 1539 with reduced exhaust air flow rate to 25 % after the main evaporation time to save energy
- EN 1539 with temporary switching off for processes in which no flammable substances are released

Forced convection chamber furnace N 5600/45 HAS with safety technology for high quantities of solvent and fresh-air filter

Model	Tmax °C	Inner dimensions in mm			Outer dimensions ² in mm			Heating power in kW ¹	Exhaust air flow rate in m ³ /h	Maximum volume of solvent in g at temperature:									
		w	d	h	W	D	H			75 °C	100 °C	125 °C	150 °C	200 °C	250 °C	300 °C	350 °C	400 °C	450 °C
NA 1000/45 LS	450	1000	1000	1000	2015	2150	2375	48	200	123	88	66	52	33	26	22	15	13	11
NA 1500/45 LS	450	1000	1500	1000	2015	2650	2375	48	200	136	98	75	59	38	31	26	18	15	14
NA 1500/45B LS	450	1500	1000	1000	2515	2150	2375	48	200	136	98	75	59	38	31	26	18	15	14
NA 2000/45 LS	450	1100	1500	1200	2115	2650	2575	72	250	172	125	95	75	49	39	33	23	20	18
NA 2000/45B LS	450	1500	1100	1200	2515	2250	2575	72	250	172	125	95	75	49	39	33	23	20	18
NA 2010/45 LS	450	1000	1000	2000	2015	2200	3375	72	250	177	128	98	78	51	41	34	24	21	18
NA 2880/45 LS	450	1200	1200	2000	2215	2400	3375	84	250	197	145	112	90	60	49	41	29	25	22
NA 4000/45 LS	450	1500	2200	1200	2515	3350	2575	84	400	291	212	163	129	85	69	58	40	35	31
NA 4000/45B LS	450	2200	1500	1200	3315	2650	2575	84	400	289	211	162	128	84	68	57	39	35	31
NA 4010/45 LS	450	1000	2000	2000	2015	3200	3375	84	400	298	218	168	133	88	72	60	42	37	33
NA 4010/45B LS	450	2000	1000	2000	3015	2200	3375	84	400	296	216	166	132	87	71	59	41	36	32
NA 4500/45 LS	450	1500	1500	2000	2550	2750	3375	84	400	307	225	174	138	92	75	63	44	38	34
NA 7200/45 LS	450	2000	1500	2400	3050	2750	3870	144	500	410	304	236	189	126	104	88	61	54	48

¹Depending on the furnace design, connected load might be higher

²External dimensions vary when furnace is equipped with additional equipment. Dimensions on request.



Safety technology, fresh air filter and vertical air circulation



Forced convection chamber furnace NA 2000/45 LS



Drive-in track with sealing elements

Ovens with Safety Technology for charges containing solvents according to EN 1539

Ovens in the TR .. LS range with safety equipment based on EN 1539 Type A are suitable for drying charges containing solvents. With their compact design, these ovens can be easily integrated into a laboratory or production process. Exhaust gases escape through an outlet on the back of the oven and can then be extracted or treated.



Oven TR 120 LS with safety technology according to EN 1539 for charges containing solvents

Standard Equipment

- Furnace technology based on ovens see page 16
- For a description of the safety technology refer to models NA 120/45 LS ff.
- Tmax 260 °C
- Temperature uniformity ± 8 K according to DIN 17052-1 in empty work space see page 94
- Controller with touch operation B510 (5 programs with 4 segments each), controls description see page 84

Additional Equipment

Refer to additional equipment for ovens on page 16

Model	Tmax °C	Inner dimensions in mm			Volume in l	Outer dimensions ³ in mm			Connected load kW ²	Electrical connection*	Weight in kg	Minutes to Tmax ⁴	Grids		Total load max. ¹
		w	d	h		W	D	H					incl.	max.	
TR 60 LS	260	450	380	350	60	700	820	710	5.3	3-phase	100	20	1	4	96
TR 120 LS	260	650	380	500	120	900	820	870	6.3	3-phase	120	22	2	7	140
TR 240 LS	260	750	540	600	240	1000	990	970	6.3	3-phase	180	32	2	8	170
TR 450 LS	260	750	540	1100	450	1000	990	1470	12.6	3-phase	250	36	3	15	250

¹Maximum load per level 30 kg

²Connected load is higher with EN 1539 as additional equipment

³External dimensions vary when furnace is equipped with additional equipment. Dimensions on request.

⁴In empty, closed furnace when connected to 230 V 1/N/PE or 400 V 3/N/PE

*Please see page 88 for more information about supply voltage



Extricable metal grids to load the oven in different layers



Oven TR 60 S with rotary mechanism



Electrical rotating device (in this case with tailored platform for PARR autoclave containers)

Chamber Ovens with Safety Technology

for charges containing solvents according to EN 1539

The safety technology integrated in chamber ovens in the KTR .. LS range makes them suitable for many processes where flammable substance evaporate from the charge.

Sensitive products, such as some silicones, require constant, gentle movement of the charge during heat treatment. The ovens can be equipped with wire frame boxes designed to suit the rotary mechanism.



Chamber oven KTR 4500 LS with fresh-air filter

Standard Equipment

- Furnace technology based on chamber ovens see page 18
- For a description of the safety technology refer to models NA 120/45 LS ff.
- Over-temperature limiter with manual reset as over-temperature protection for the oven and the charge
- Controller with touch operation P570 (50 programs with each 40 segments), controls description see page 84

Additional Equipment

- Fresh-air filter
- Air circulation filter for the internal air
- Drive-in tracks
- Charging cart
- Customer-specific rotary rack

Maximum quantities of silicone per charge with a fresh-air volume of 120 L/min/kg_{silicone}

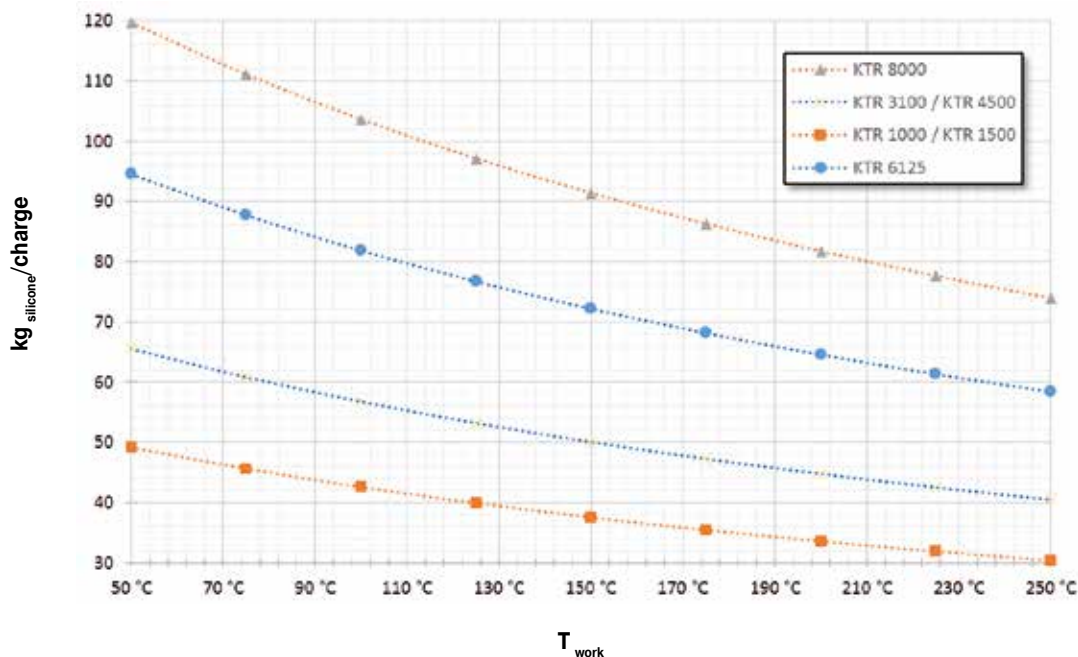

To ensure safe operation of the oven when tempering silicone, the fresh air supply of the oven must be monitored. A fresh air volume flow of 100 - 120 l/min/kg silicone (6-7,2 m³/h/kg silicone) has to be considered. The graph shows the maximum amount of silicone depending on the operating temperature for various KTR models at a fresh air supply of 120 l/min/kg silicone. The oven will be carried out in accordance with the requirements of the standard EN 1539.



Chamber oven KTR 3100 DT with rotating system for tempering of silicone parts. Four baskets will be charged in the frame and can be taken out separately

Model	Tmax °C	Inner dimensions in mm			Volume in l	Outer dimensions ² in mm			Heating power in kW ¹	Exhaust air volu- metric flow rate in Bm ^{3/h}	Maximum volume of solvent in g at temperature:					
		w	d	h		W	D	H			50 °C	100 °C	150 °C	200 °C	250 °C	260 °C
KTR 1000 LS	260	1000	1000	1000	1000	1900	1430	2315	36	390	325	141	77	52	41	39
KTR 1500 LS	260	1000	1000	1500	1500	1900	1430	2815	36	390	342	153	88	58	46	44
KTR 3100 LS	260	1250	1250	2000	3100	2150	1680	3455	45	520	492	227	134	90	72	69
KTR 4500 LS	260	1500	1500	2000	4500	2400	1930	3455	54	520	536	256	155	106	85	82
KTR 6125 LS	260	1750	1750	2000	6125	2650	2200	3600	63	750	757	359	216	147	118	114
KTR 8000 LS	260	2000	2000	2000	8000	2900	2450	3600	81	950	963	457	275	187	151	145

¹Depending on the furnace design, connected load might be higher

²External dimensions vary when furnace is equipped with additional equipment. Dimensions on request.



Drive-in ramps for chamber oven with floor insulation



Electrically heated chamber oven KTR 1500 for drying foundry cores with an alcohol-based binder



Removable base on rollers to reduce weight

Forced Convection Furnaces up to 850 °C

The forced convection furnaces presented in this chapter are ideal for processes such as tempering, aging, or others that take place at temperatures up to a maximum of 850 °C. Good heat transfer and temperature uniformity are important for these processes. The powerful air circulation and air flow are optimized for each individual model, which leads to very good temperature uniformity, even in the standard version.

The following equipment applies to all furnaces in this chapter:



Over-temperature limiter with adjustable cutout temperature as temperature limiter to protect the furnace and load



Exclusive use of insulation materials without categorization according to EC Regulation No 1272/2008 (CLP). This explicitly means that alumino silicate wool, also known as “refractory ceramic fiber” (RCF), which is classified and possibly carcinogenic, is not used.



Defined application within the constraints of the operating instructions



Controller with intuitive touch operation



NTLog Basic for Nabertherm controller: recording of process data with USB-flash drive



Freeware NTEdit for convenient program input via Excel™ for Windows™ on the PC



Freeware NTGraph for evaluation and documentation of firings using Excel™ for Windows™ on the PC



MyNabertherm App for online monitoring of the firing on mobile devices for free download



As additional equipment: Process control and documentation via VCD software package for monitoring, documentation and control



Furnace Group	Model	Page
Forced convection chamber furnaces – tabletop design	NAT	32
Forced convection chamber furnaces up to 675 liter	NA	34
Forced convection chamber furnaces from 1000 liter	N .. HA NA	36
Forced convection pit-type furnaces	SAL, SAH	40
Pit-type and top-loading furnaces with or without air circulation	S	42
Drawer furnaces	NA	43
Forced convection bogie hearth furnaces	W .. A	44

Forced Convection Chamber Furnaces – Tabletop Design electrically heated

These forced convection chamber furnaces are characterized by their extremely high temperature uniformity. Due to the compact tabletop design, this series is very well suited for installation in laboratories or rooms with limited space.

Applications include preheating of components for shrink-fit processes, heat treatment of metals in air such as aging, stress relieving, soft annealing or tempering, and heat treatment of glass.



Forced convection chamber furnace NAT 15/85 with base frame as additional equipment

Standard Equipment

- Tmax 650 °C or 850 °C
- Horizontal air circulation with optimum distribution through stainless steel baffles
- Dual shell housing made of textured stainless steel sheets with additional fan cooling for low surface temperature
- Integrated control unit
- Swing door hinged on the right side, door opening temperatures up to 400 °C
- Temperature uniformity up to ± 6 °C according to DIN 17052-1 (model NAT 15/65 up to ± 5 °C) see page 94
- Optimum air distribution enabled by high flow speeds
- Air inlet in the rear wall of the furnace
- Adjustable exhaust port in the furnace ceiling (not for model NAT 15/65)
- 15 mm port in the furnace ceiling (not for model NAT 15/65)
- Controller with touch operation B500/B510 (5 programs with 4 segments each), controls description see page 84



Forced convection chamber furnace NAT 30/65

Additional Equipment (not for NAT 15/65)

- Base frame
- Charging racks for loading on several levels
- Equipment package with batch control and process control and documentation via VCD software package



Forced convection chamber furnace NAT 30/85



Forced convection chamber furnace NAT 50/85

Model	Tmax °C	Inner dimensions in mm			Volume in l	Outer dimensions ¹ in mm			Heating power in kW ²	Electrical connection*	Weight in kg	Heat-up time ³ to Tmax in minutes
		w	d	h		W	D	H				
NAT 15/65	650	295	340	170	15	470	790	460	2,8	1-phase	60	40
NAT 30/65	650	320	320	300	30	810	620	620	3,0	1-phase	90	80
NAT 60/65	650	400	400	400	60	890	700	720	3,0	1-phase	110	100
NAT 15/85	850	320	320	150	15	690	880	570	3,0	1-phase	85	190
NAT 30/85	850	320	320	300	30	690	880	720	3,0	1-phase	100	230
NAT 50/85	850	400	320	400	50	770	880	820	4,5	3-phase	130	230

¹External dimensions vary when furnace is equipped with additional equipment. Dimensions on request.

²Depending on furnace design connected load might be higher

³Approx. information in empty furnace

*Please see page 88 for more information about supply voltage

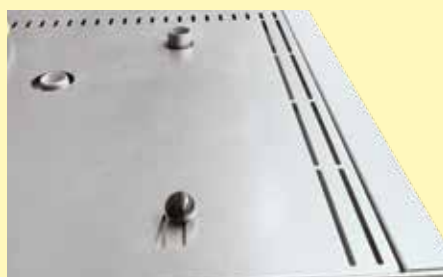

Adjustable exhaust port in the furnace ceiling



Forced convection chamber furnace NAT 15/85



Interior made of stainless steel sheet 1.4828

Forced Convection Chamber Furnaces up to 675 Liter electrically heated

The very good temperature uniformity of these chamber furnace with air circulation provides for ideal process conditions for annealing, curing, solution annealing, artificial ageing, sintering of PTFE, preheating, or soft annealing and brazing. The forced convection chamber furnaces are equipped with a suitable annealing box for soft annealing of copper or tempering of titanium, and also for annealing of steel under non-flammable protective or reaction gases. The modular forced convection chamber furnace design allows for adaptation to specific process requirements with appropriate accessories.



Forced convection chamber furnace NA 500/65

Standard Equipment

- Tmax 450 °C, 650 °C, or 850 °C
- Horizontal air circulation with optimum distribution through stainless steel baffles
- Swing door hinged on the right side
- Base frame included in the delivery
- Temperature uniformity up to ± 4 °C according to DIN 17052-1 see page 94
- Optimum air distribution enabled by high flow speeds
- One frame sheet and rails for two additional trays included in the scope of delivery
- Controller with touch operation B500 (5 programs with 4 segments each), controls description see page 84

Additional Equipment for Models up to 450 °C

- Air inlet and exhaust air flaps when used for drying
- Controlled cooling via controlled flap and fan
- Additional frame sheet
- Gas supply boxes for different charging methods
- Gas feed fittings
- Charge control with documentation of the charge thermocouple
- Signal tower
- Charging systems

Further Additional Equipment for Models up to 850 °C

- Optimization of the temperature uniformity up to ± 3 °C according to DIN 17052-1 see page 94
- Measuring frames and thermocouples for TUS measurements charge or comparative measurements
- Version according to AMS2750G or CQI-9
- Manual lift door (up to model NA 120/..)
- Pneumatic lift door
- Manual roller conveyor in furnace chamber for high charge weights



Forced convection chamber furnace NA 250/85



Forced convection chamber furnace NA 250/45



Forced convection chamber furnace NA 60/85 with manual lift door and protective gas box for front loading

Model	Tmax °C	Inner dimensions in mm			Volume in l	Outer dimensions ¹ in mm			Heating power in kW ²	Electrical connection*	Weight in kg	Heat-up time ³ to Tmax in minutes		Cool-down time ³ from Tmax to 150 °C in minutes	
		w	d	h		W	D	H				Flaps ⁴	Fan cooling ⁴		
NA 120/45	450	450	600	450	120	1250	1550	1550	9.0	3-phase	460	60	240	30	
NA 250/45	450	600	750	600	250	1350	1650	1725	12.0	3-phase	590	60	120	30	
NA 500/45	450	750	1000	750	500	1550	1900	1820	18.0	3-phase	750	60	240	30	
NA 60/65	650	350	500	350	60	910	1390	1475	9.0	3-phase	350	120	270	60	
NA 120/65	650	450	600	450	120	990	1470	1550	12.0	3-phase	460	60	300	60	
NA 250/65	650	600	750	600	250	1170	1650	1680	20.0	3-phase	590	90	270	60	
NA 500/65	650	750	1000	750	500	1290	1890	1825	27.0	3-phase	750	60	240	60	
NA 60/85	850	350	500	350	60	790	1330	1440	9.0	3-phase	315	150	900	120	
NA 120/85	850	450	600	450	120	890	1420	1540	12.0	3-phase	390	150	900	120	
NA 250/85	850	600	750	600	250	1120	1690	1810	20.0	3-phase	840	180	900	180	
NA 500/85	850	750	1000	750	500	1270	1940	1960	30.0	3-phase	1150	180	900	210	
NA 675/85	850	750	1200	750	675	1270	2190	1960	30.0	3-phase	1350	210	900	210	

¹External dimensions vary when furnace is equipped with additional equipment. Dimensions on request.

²Depending on furnace design connected load might be higher

³Approx. information in empty furnace

⁴Additional equipment

*Please see page 88 for more information about supply voltage



Port for thermocouple



Tray



Roller conveyor in furnace chamber

Forced Convection Chamber Furnaces from 1000 Liter electrically heated

These forced convection chamber furnaces are available for maximum operating temperatures of 450 °C, 600 °C or 850 °C and are suitable for a wide range of processes. Due to their robust and solid design even heavy loads can be heat treated. These furnaces are suited for use with baskets, pallets, and mobile furnace racks. The charging can be carried out with fork lift, pallet truck, or charging trolley. Charging can be simplified by roller conveyors, if necessary also motorized. All furnaces are available with electric heating or gas heating.



Forced convection chamber furnace NA 3240/45S

Standard Equipment for Models up to 600 °C

- Tmax 450 °C or 600 °C
- Electrically heated
- Electric heating by means of heater coils
- Horizontal air circulation (type ../HA)
- High air exchange for perfect heat transfer
- Temperature uniformity up to +/- 5 °C according to DIN 17052-1 see page 94
- Furnace chamber lined with alloy 1.4301 (DIN)
- High quality mineral wool insulation provides for low outer temperatures
- Inside unlocking device for furnaces with walk-in work space
- Furnace sizes suitable for common charging systems, such as pallets, baskets, etc.
- Double-wing door for furnaces with an internal width of more than 1500 mm (450 °C models). Furnaces for higher temperatures and with smaller sizes are equipped with a single-wing door.
- Controller with touch operation B500 (5 programs with 4 segments each), controls description see page 84



Forced convection furnace NA 4010/45 with track cutouts, chamber lighting and observation window

Additional Equipment for Models up to 600 °C

- Direct gas heating or upon request with indirect gas heating with radiation tube, e. g. for heat treatment of aluminum
- Entry ramps for palet truck or drive-in tracks for entry of charging carts for models with floor insulation (not for 600 °C models)
- Electro-hydraulic lift door
- Cooling systems for faster cooling
- Motor-driven control of air inlet and exhaust air flaps for better ventilation of the furnace chamber
- Observation window and/or furnace chamber lighting (not for 600 °C models)
- Optimization of the temperature uniformity up to +/- 3 °C according to DIN 17052-1 see page 94
- Charging systems or roller conveyors, also electrically driven provide for easy charging
- Power-reduced version to save energy on request



Forced convection chamber furnace NA 4000/45



Forced convection chamber furnace NA 5600/45S



Forced convection chamber furnace NA 1500/45 on base with guide rails and end stop for a custom-built charging forklift, custom-built charge support and ramming protection



Drive-in ramps at furnaces with bottom insulation for processes which require a good temperature uniformity



Forced convection chamber furnace N 1500/85HA with electric charging system for heavy loads

Standard Equipment for Models 850 °C

- Tmax 850 °C
- Electrically heated
- Electric heating with heating elements on supports tubes
- Optimal air circulation for your charge by means of adjustable air outlets
- Horizontal air circulation (type ../HA)
- High air exchange provides for perfect heat transfer
- Base frame with 500 mm charging height
- Temperature uniformity up to +/- 5 °C according to DIN 17052-1 see page 94
- Air baffles made of 1.4828 (DIN)
- High quality mineral wool insulation provides for low outer temperatures
- Furnaces sizes perfectly suited to accommodate common charging systems, e. g. like pallets or pallet boxes
- Controller with touch operation B500 (5 programs with 4 segments each), controls description see page 84

Additional Equipment for Models 850 °C

- Direct gas heating into the outlet of the air circulation fan
- Electro-hydraulic lift door
- Cooling systems for faster cooling
- Motor-driven air inlet and control of exhaust air flaps for better ventilation of the furnace chamber
- Optimization of the temperature uniformity up to +/- 3 °C according to DIN 17052-1 see page 94
- Base frame for customized charging height
- Charging systems or roller conveyors, also electrically driven provide for easy charging



Model	Tmax °C	Inner dimensions in mm			Volume in l	Outer dimensions ¹ in mm			Circulation rate m ³ /h	Heating power in kW ²	Electrical connection*
		w	d	h		W	D	H			
NA 1000/45	450	1000	1000	1000	1000	2015	2150	1700	3600	36	3-phase
NA 1500/45	450	1000	1500	1000	1500	2015	2650	1700	3600	36	3-phase
NA 1500/45B	450	1500	1000	1000	1500	2515	2150	1700	3600	36	3-phase
NA 2000/45	450	1100	1500	1200	2000	2115	2650	1870	6400	48	3-phase
NA 2000/45B	450	1500	1100	1200	2000	2515	2250	1870	6400	48	3-phase
NA 2010/45	450	1000	1000	2000	2000	2015	2200	2670	9000	48	3-phase
NA 2880/45	450	1200	1200	2000	2880	2215	2400	2670	9000	60	3-phase
NA 4000/45	450	1500	2200	1200	4000	2515	3350	1870	6400	60	3-phase
NA 4000/45B	450	2200	1500	1200	4000	3315	2650	1870	6400	60	3-phase
NA 4010/45	450	1000	2000	2000	4000	2015	3200	2670	9000	60	3-phase
NA 4010/45B	450	2000	1000	2000	4000	3015	2200	2670	9000	60	3-phase
NA 4500/45	450	1500	1500	2000	4500	2550	2750	2670	9000	60	3-phase
NA 7200/45	450	2000	1500	2400	7200	3050	2750	3070	9000	108	3-phase
NA 1000/60	600	1000	1000	1000	1000	2015	2150	1700	3600	36	3-phase
NA 1500/60	600	1000	1500	1000	1500	2015	2650	1700	3600	36	3-phase
NA 1500/60B	600	1500	1000	1000	1500	2515	2150	1700	3600	36	3-phase
NA 2000/60	600	1100	1500	1200	2000	2115	2650	1870	6400	48	3-phase
NA 2000/60B	600	1500	1100	1200	2000	2515	2250	1870	6400	48	3-phase
NA 2010/60	600	1000	1000	2000	2010	2015	2200	2670	9000	48	3-phase
NA 2880/60	600	1200	1200	2000	2010	2215	2400	2670	9000	60	3-phase
NA 4000/60	600	1500	2200	1200	4000	2515	3350	1870	6400	60	3-phase
NA 4000/60B	600	2200	1500	1200	4000	3315	2650	1870	6400	60	3-phase
NA 4010/60	600	1000	2000	2000	4010	2015	3200	2670	9000	60	3-phase
NA 4010/60B	600	2000	1000	2000	4010	3015	2200	2670	9000	60	3-phase
NA 4500/60	600	1500	1500	2000	4500	2550	2750	2670	9000	60	3-phase
NA 7200/60	600	2000	1500	2400	7200	3050	2750	3070	9000	108	3-phase
N 1000/85HA	850	1000	1000	1000	1000	2100	2160	1900	3400	40	3-phase
N 1500/85HA	850	1500	1000	1000	1500	2600	2000	1900	6400	40	3-phase
N 1500/85HA1	850	1000	1500	1000	1500	2100	2600	1900	6400	40	3-phase
N 2000/85HA	850	1500	1100	1200	2000	2700	2320	2100	9000	60	3-phase
N 2000/85HA1	850	1100	1500	1200	2000	2300	2800	2100	9000	60	3-phase
N 4000/85HA	850	1500	2200	1200	4000	2700	3700	2100	12600	90	3-phase

¹External dimensions vary when furnace is equipped with additional equipment. Dimensions on request.

²Depending on furnace design connected load might be higher

*Please see page 88 for more information about supply voltage



Drive-in ramps at furnaces with bottom insulation for processes which require a good temperature uniformity



Forced convection chamber furnaces, gas fired, e. g. with compact burner



Enclosed heater coils on electrically heated models with Tmax 450 °C and 600 °C



Directly gas-fired forced convection chamber furnace NB 10080/26HAS with driven charging cart

Forced Convection Pit-Type Furnaces

electrically heated

Forced convection pit-type furnaces offer the advantage of easy charging, for heat treatment of heavy parts or loads in charge baskets. With maximum application temperatures available from 850 °C, these compact pit-type furnaces are particularly useful for processes such as tempering, solution annealing, artificial ageing, and soft annealing.



Pit-type furnace SAL 120/85 with protective gas retort box and cooling station next to the furnace

Standard Equipment

- Tmax 850 °C
- Air circulation fans in the furnace bottom, high circulation rate
- Vertical air circulation with square air heating chamber
- Temperature uniformity up to +/- 4 °C according to DIN 17052-1 see page 94
- Interior walls from stainless steel
- Controller with touch operation B500 (5 programs with 4 segments each), controls description see page 84

Additional Equipment

- Charging hoist with swivel arm and charge basket
- Optimization of the temperature uniformity up to +/- 2 °C according to DIN 17052-1 see page 94
- Integrated fan for rapid cool down or separate cooling station for annealing box cooling outside of the furnace
- Protective gas box/retort with protective gas inlet and outlet for production in a defined atmosphere
- Manual or automatic gas supply systems for non-flammable protective or reaction gases

Model	Tmax °C	Inner dimensions in mm			Volume in l	Max. charging weight in kg	Outer dimensions ¹ in mm			Heating power in kW ²	Electrical connection*	Weight in kg
		w	d	h			W	D	H			
SAL 120/85	850	450	450	600	120	80	1300	1100	1450	13	3-phase	400
SAL 250/85	850	600	600	750	250	250	1500	1300	1600	20	3-phase	600
SAL 500/85	850	750	750	900	500	250	1600	1400	1800	30	3-phase	800

¹External dimensions vary when furnace is equipped with additional equipment. Dimensions on request.

²Depending on furnace design connected load might be higher

*Please see page 88 for more information about supply voltage

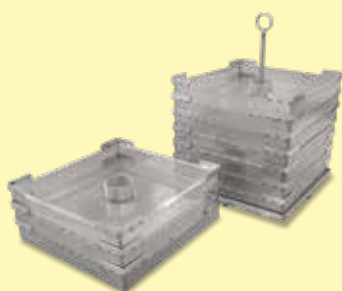

Charging system with stackable loading baskets



Pit-type furnace SAL 250/85



Pit-type furnace SAL 250/85 with charging hoist with swivel arm and charge basket

Forced Convection Pit-Type Furnaces electrically heated or gas-fired

Due to their robust design, these pit-type furnaces with air circulation are particularly useful for a professional heat treatment demanding optimum temperature uniformity. Production processes such as tempering, solution annealing, artificial ageing, and soft annealing can be realized with these pit-type furnaces.

Standard Equipment

- Tmax 600 °C or 850 °C
- Useful for heavy charge weights
- Powerful air circulation fan in the furnace lid for vertical air-circulation in the furnace chamber
- Heating chamber with air baffle cylinder, feeding the recirculated air through the bottom grid
- Pneumatic or hydraulic lifting device for swing lid
- Temperature uniformity up to ± 3 °C according to DIN 17052-1 see page 94
- Controller with touch operation C540 (10 programs with each 20 segments), controls description see page 84

Additional Equipment

- Controlled cooling for accelerated charge cooling
- Optimization of the temperature uniformity up to ± 2 °C according to DIN 17052-1 see page 94
- Variable rpm converter control of the air circulation velocity
- Motorized rolling lid or fully pneumatic/hydraulic swing lid



Forced Convection Pit-Type Furnace SAH 3900/60S

Model	Tmax °C	Inner dimensions cond. cylinder		Volume in l	Max. charging weight in kg	Outer dimensions ² in mm			Heating power in kW ¹	Electrical connection*
		ø in mm	h in mm			W	D	H		
SAH 200/..		600	800	200	400	1460	1460	1850	27	3-phase
SAH 300/..		600	1000	300	400	1460	1460	2050	27	3-phase
SAH 500/..	600	800	1000	500	600	1660	1660	2050	36	3-phase
SAH 600/..	or	800	1200	600	600	1660	1660	2250	54	3-phase
SAH 800/..	850	1000	1000	800	1000	2000	2000	2050	63	3-phase
SAH 1000/..		1000	1300	1000	1000	2000	2000	2400	81	3-phase
SAH 1280/..		800	1600	1300	800	1660	1660	2800	81	3-phase
SAH 5600/..		1800	2200	5600	5000	2700	3000	3900	120	3-phase

¹Depending on furnace design connected load might be higher

²External dimensions vary when furnace is equipped with additional equipment. Dimensions on request.

*Please see page 88 for more information about supply voltage



Motor-driven fresh-air and exhaust air flaps



Forced convection pit-type furnaces S 10400/75 AS in production



Forced convection pit-type furnaces SAH 5600/75 S in production

Pit-Type and Top-Loading Furnaces with or without Air Circulation electrically heated or gas-fired

Our top-loading furnaces are perfectly suited for the heat treatment of longer or heavier components. The furnace is usually charged with a factory crane. Due to their high-performance air circulation, the furnaces provide for excellent temperature uniformity up to a maximum temperature of 850 °C. The top-loading furnaces for the temperature range up to 1280 °C provide for very good temperature uniformity due to their five-side heating. Alternatively, these furnaces can also be provided with gas heating. Customized dimensions are designed and produced to accommodate the size and weight of the components to be treated.



Pit-type furnace S 480/S

Standard Equipment

- Tmax up to 850 °C for furnaces with air circulation
- Tmax up to 1280 °C for furnaces with radiation heating
- Electrically heated or gas-fired
- Heating from both long sides for furnaces with air circulation
- Heating from all four sides and the bottom with SiC plates in the bottom as level stacking support for models to 900 °C or 1280 °C
- Depending on the furnace model, manual or electrohydraulic opening system of the lid with two-hand operation
- Closable air supply vents in the lower area of the furnace chamber
- Closable exhaust air flaps in the lid
- Controller with touch operation C540 (10 programs with each 20 segments), controls description see page 84



Pit-type furnace S 11988/S with rolling lid

Additional Equipment

- Motor-driven exhaust air flaps for faster cooling
- Controlled fan cooling with motor-driven exhaust air flaps
- Multi-zone control of the heating provides for optimum temperature uniformity
- Furnace chamber can be divided in length for short workparts, partitions can be controlled separately
- Designed for Tmax 950 °C, fan blade driven indirectly via a belt to protect the air recirculation motor against over-heating



Charge supports for long tubes in a top-loading forced convection furnace SAL 750/08



Top-loading furnace S 432/S



Furnace chamber S 5120/GS with receptacle for an insulating plate in order to divide the furnace chamber

Drawer Furnaces electrically heated

Drawer furnaces or multi-chamber furnaces are ideally suited for drying processes and the heat treatment of light and flat parts that are cyclically loaded and unloaded by the operator. Due to their compact design, different parts can be heat treated with different dwell times. Typical applications are e. g. tempering of plexiglass (plastics), drying of textiles or preheating of parts with low weights. The furnaces can be used for working temperatures up to 300 °C and can be customized with multiple drawers or extracts. On request, temperature displays or dwell timers can also be integrated for each extract, which show the status of the loaded extract.



Multi-chamber furnace NA 4400/26HAS

Standard Equipment

- Electrically heated by a chrome radiation heater
- Powerful air circulation results in a good temperature uniformity in the individual compartments
- The front of the drawer is available in various designs, e. g. with a flap door or as a door with a pull-out drawer
- Maintenance door in the front
- Drawers can be partially or fully extended
- Robust design for industrial use
- Controller with touch operation B500 (5 programs with 4 segments each), controls description see page 84

Additional Equipment

- Dwell timer and temperature displays per compartment
- Cooling systems for faster cooling of the furnace
- Safety technology for charges containing solvents in accordance with the EN 1539 standard
- Design and documentation for each compartment in accordance with automotive and aviation standards CQI9/AMS2750



Drawer furnace NA 5320/S

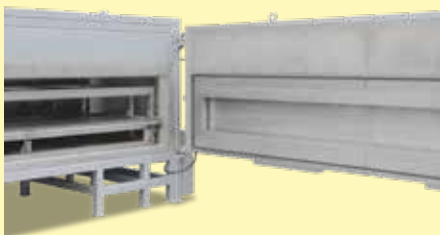

Maintenance door drawer furnace NA 5320/S

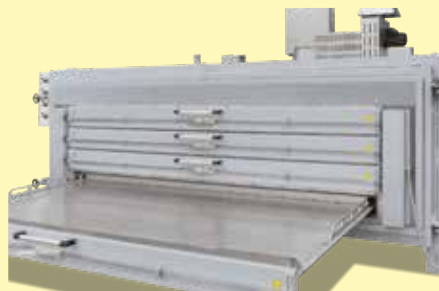

Drawer furnace NA 6700/26HAS with 4 drawers for heat treatment of flat components



Multi-chamber furnace NA 4400/26 for different holding times

Forced Convection Bogie Hearth Furnaces

electrically heated or gas-fired

The forced convection bogie hearth furnaces W 1000/60A - W 8300/85A are used when heavy charges weighing have to be heat-treated. They are ideal for processes such as solution annealing, artificial ageing, annealing or soft annealing, for which a high degree of temperature uniformity is crucial. The high-performance air circulation assures that the temperature uniformity achieved throughout the work space is outstanding. A broad selection of additional equipment enables these bogie hearth furnaces to be optimally adapted to suit specific processes.



Forced convection bogie hearth furnace W 3300/85A with perforated sheet support



Forced convection bogie hearth furnace W 5290/85 AS with annealing box for heat treatment of coils under protective gas

Standard Equipment

- Tmax 600 °C or 850 °C
- Dual shell housing with rear ventilation provides for low shell temperatures for the 850 °C models
- Swing door hinged on the right side
- Heating from chrome steel heating elements for the 600 °C models
- Heating from three sides (both side walls and the trolley) for the 850 °C models. Bottom heating protected by SiC tiles.
- Lochblechauflage oder alternativ Balkenaufilage auf dem Herdwagen zur gleichmäßigen Lastverteilung
- High-performance air circulation fan with vertical circulation
- Temperature uniformity up to ± 5 °C according to DIN 17052-1 see page 94
- Furnace chamber fitted with inner sheets made of stainless steel 1.4301 for 600 °C models and of 1.4828 for 850 °C models
- Insulation structured with high-quality mineral wool for 600 °C models
- Bogies with flanged wheels running on rails for easy and precise movement of heavy loads
- Electric chain-driven bogie in combination with rail operation for smooth movement of heavy loads from model W 4800
- Controller with touch operation B500 (5 programs with 4 segments each), controls description see page 84

Additional Equipment

- Direct gas heating or upon request with indirect gas heating with radiation tube
- Electric chain-driven bogie in combination with rail operation for smooth movement of heavy loads up to Model W 4000
- Optimization of the temperature uniformity up ± 3 °C according to DIN 17052-1 see page 94
- Different possibilities for an extension to a bogie hearth furnace plant:
 - Additional bogies
 - Bogie transfer system with parking rails to exchange bogies running on rails or to connect multiples furnaces
 - Motor-driven bogies and cross-traversal system
 - Fully automatic control of the bogie exchange
- Electro-hydraulic lift door
- Motorized fresh-air and exhaust air flaps, adjustable via the program
- Cooling systems for faster rapid cooling
- Bar supports with grids for higher charge weights and/or better load distribution with point leads



Forced convection bogie hearth furnace W 24750/60AS for annealing aluminum coils

Model	Tmax °C	Inner dimensions in mm			Volume in l	Max. charging weight in kg	Outer dimensions ¹ in mm			Heating power in kW ²	Electrical connection*
		w	d	h			W	D	H		
W 1000/.. A	600	800	1600	800	1000	800	1780	2450	2350	48	3-phase
W 1600/.. A	600	1000	1600	1000	1600	1000	1920	2450	2510	48	3-phase
W 2200/.. A	600	1000	2250	1000	2200	1500	1980	3100	2560	96	3-phase
W 3300/.. A	600	1200	2250	1200	3300	1900	2180	3100	2750	96	3-phase
W 4000/.. A	600	1500	2250	1200	4000	2400	2480	3100	2800	120	3-phase
W 4800/.. A	600	1200	3300	1200	4800	2800	2180	4380	2850	120	3-phase
W 6000/.. A	600	1500	3300	1200	6000	3700	2480	4380	2900	144	3-phase
W 6600/.. A	600	1200	4600	1200	6600	4000	2280	5680	2780	144	3-phase
W 7500/.. A	600	1400	3850	1400	7500	4000	2380	4930	3020	144	3-phase
W 8300/.. A	600	1500	4600	1200	8300	5200	2580	5680	2950	192	3-phase
W 1000/.. A	850	800	1600	800	1000	800	1780	2450	2350	45	3-phase
W 1600/.. A	850	1000	1600	1000	1600	1000	1920	2450	2510	45	3-phase
W 2200/.. A	850	1000	2250	1000	2200	1500	1980	3100	2560	90	3-phase
W 3300/.. A	850	1200	2250	1200	3300	1900	2180	3100	2750	90	3-phase
W 4000/.. A	850	1500	2250	1200	4000	2400	2480	3100	2800	110	3-phase
W 4800/.. A	850	1200	3300	1200	4800	2800	2180	4380	2850	110	3-phase
W 6000/.. A	850	1500	3300	1200	6000	3700	2480	4380	2900	140	3-phase
W 6600/.. A	850	1200	4600	1200	6600	4000	2280	5680	2780	140	3-phase
W 7500/.. A	850	1400	3850	1400	7500	4000	2380	4930	3020	140	3-phase
W 8300/.. A	850	1500	4600	1200	8300	5200	2580	5680	2950	185	3-phase

¹External dimensions vary when furnace is equipped with additional equipment. Dimensions on request.

²Depending on furnace design connected load might be higher

*Please see page 88 for more information about supply voltage



Cooling fan for accelerated cooling



Burner system of gas-fired forced convection bogie hearth furnace WB 4000/85 AS

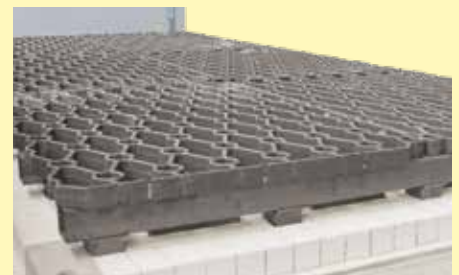

Bar support with grating for even load distribution

Chamber Furnaces, Bogie Hearth Furnaces and Top Hat Furnaces up to 1400 °C

Furnaces with radiant heating are used for steel annealing at high temperatures. The heating elements are arranged in such a way that a good temperature uniformity is ensured at working temperatures above 900 °C. In order to minimize the heat loss when opening hot, the height of the furnace chamber of these furnaces is lower than, for example, with convection furnaces. For heavy or large batches, for which heat treatment in a chamber furnace is out of the question, bogie hearth furnaces or top hat furnaces can be offered.

As an alternative to electrical heating, especially in the case of larger furnaces, the furnaces can also be gas-fired.

The following equipment applies to all furnaces in this chapter:



Over-temperature limiter with adjustable cutout temperature as temperature limiter to protect the furnace and load



Exclusive use of insulation materials without categorization according to EC Regulation No 1272/2008 (CLP). This explicitly means that alumino silicate wool, also known as “refractory ceramic fiber” (RCF), which is classified and possibly carcinogenic, is not used.



Defined application within the constraints of the operating instructions



Controller with intuitive touch operation



As additional equipment: Process control and documentation via VCD software package for monitoring, documentation and control



Furnace Group	Model	Page
Chamber furnaces, electrically heated	N ../H, N../HR, N ../13	48
Chamber furnaces, sheet metal preheating furnaces	N 731 - N 2401	50
Bogie hearth furnaces	WS	52
Gas-fired bogie hearth furnaces up to 1400 °C	WB	54
Chamber furnaces, gas-fired	NB	55
Top hat furnaces or bottom loading furnaces with wire heating up to 1400 °C	H ../LB H ../LT	56

Chamber Furnaces electrically heated

These universal chamber furnaces with radiation heating have been specifically designed to withstand heavy-duty use in the tool shop and industry. They are particularly useful for processes such as tool making or for hardening jobs, e.g. annealing, hardening and forging. With help of various accessories, these furnaces can be customized to every application requirements.



Annealing furnace N 7/H, as table-top model with optional protective gas box



Chamber furnace N 41/H with optional protective gas box

Standard Equipment

- Compact, robust design construction with double-walled housing
- Door can be opened when furnace is hot
- Deep furnace chamber with three-sides heating: from both side walls and bottom
- Heating elements on support tubes ensure free heat radiation and a long service life
- Bottom heating protected by heat-resistant SiC plate (models N 81/.. - N 641/.. also with side SiC plates)
- Stainless steel upper door jamb protects furnace structure when furnace is opened hot up to model N 87/H. Models N 81/... - N 641/.. with compact stainless steel door.
- Temperature uniformity up to ± 10 °C according to DIN 17052-1 see page 94
- Low energy consumption due to multi-layer insulation
- Base frame included in the delivery, N 7/H - N 17/HR designed as table-top model
- Exhaust opening in the side of the furnace, or on rear wall of chamber furnace in the N 31/H models and higher
- Parallel swinging door (user protected from heat radiation) up to N 87/H guided downwards, from N 81 guided upwards
- Door movement cushioned with gas dampers/struts
- Heat resistant zinc paint for protection of door and door frame (for model N 81 and larger)
- NTLog Basic for Nabertherm controller: recording of process data with USB-flash drive
- Controller with touch operation B500 (5 programs with 4 segments each), controls description see page 84
- Freeware NTEdit for convenient program input via Excel™ for Windows™ on the PC
- Freeware NTGraph for evaluation and documentation of firings using Excel™ for Windows™ on the PC
- MyNabertherm App for online monitoring of the firing on mobile devices for free download

Additional Equipment

- Side heating elements protected with SiC tiles
- Thermocouple inlet with a diameter of 15 mm in the side
- Pneumatic door opening, controlled by foot pedal
- Protective gas boxes for heat treatment under non-flammable protective and reaction gases
- Gas feed fittings
- Charging devices
- Charge control



Chamber furnace N 87/H



Chamber furnace N 81/13 with pneumatic lift door

Model	Tmax °C	Inner dimensions in mm			Volume in l	Outer dimensions ⁴ in mm			Heating power in kW ³	Electrical connection [*]	Weight in kg
		w	d	h		W	D	H			
N 7/H ¹	1280	250	250	140	9	800	650	600	3.0	1-phase	60
N 11/H ¹	1280	250	350	140	11	800	750	600	3.5	1-phase	70
N 11/HR ¹	1280	250	350	140	11	800	900	600	5.5	3-phase ²	70
N 17/HR ¹	1280	250	500	140	17	800	900	600	6.4	3-phase ²	90
N 31/H	1280	350	350	250	30	1040	1030	1340	15.0	3-phase	210
N 41/H	1280	350	500	250	40	1040	1180	1340	15.0	3-phase	260
N 61/H	1280	350	750	250	60	1040	1430	1340	20.0	3-phase	400
N 87/H	1280	350	1000	250	87	1040	1680	1340	25.0	3-phase	480
N 81	1200	500	750	250	80	1300	2000	2000	20.0	3-phase	950
N 161	1200	550	750	400	160	1350	2085	2300	30.0	3-phase	1160
N 321	1200	750	1100	400	320	1575	2400	2345	47.0	3-phase	1570
N 641	1200	1000	1300	500	640	1850	2850	2650	70.0	3-phase	2450
N 81/13	1300	500	750	250	80	1300	2000	2000	22.0	3-phase	970
N 161/13	1300	550	750	400	160	1350	2085	2300	35.0	3-phase	1180
N 321/13	1300	750	1100	400	320	1575	2400	2345	60.0	3-phase	1600
N 641/13	1300	1000	1300	500	640	1850	2850	2650	80.0	3-phase	2500

¹Table-top model

²Heating only between two phases

³Depending on furnace design connected load might be higher

⁴External dimensions vary when furnace is equipped with additional equipment. Dimensions on request.

*Please see page 88 for more information about supply voltage



Working with protective gas boxes for a protective gas atmosphere using a charging cart



Chamber furnace N 7/H as table-top model



Deep furnace chamber with three-sides heating

Chamber Furnaces, Sheet Metal Preheating Furnaces electrically heated

These very rugged chamber furnaces with radiation heating are designed for continuous heat-treatment processes. They are ideally suited for forming processes such as forging or hot forming steel sheets. The use of a wide variety of accessories enables these furnaces to be tailored to the relevant application.



Chamber furnace with electro-hydraulic lift door on transportable base for preheating of large steel sheets for the automotive industry.

Standard Equipment

- Tmax 1200 °C
- Very rugged design
- Five-sided heating from both sides, bottom, rear wall and door
- Heating elements installed on ceramic support tubes enable unimpaired heat radiation
- Bottom heating protected by heat-conducting SiC plate
- Manual lift for chamber furnaces to N 951
- Electro-hydraulic lift door for chamber furnaces from N 1296
- Temperature uniformity up to ± 7.5 °C according to DIN 17052-1 see page 94
- Closable measuring port for customer's temperature measuring system
- Holding time measurement for the charge until it goes to forging or forming of steel sheets: After charging, the operator presses a key and the previously defined holding time for the load begins to run. The end of the holding time is indicated by both acoustic and optical signals, meaning that the charge can be removed.
- Heat resistant zinc paint for protection of door and door frame
- NTLog Basic for Nabertherm controller: recording of process data with USB-flash drive
- Controller with touch operation B500 (5 programs with 4 segments each), controls description see page 84
- Freeware NTEdit for convenient program input via Excel™ for Windows™ on the PC
- Freeware NTGraph for evaluation and documentation of firings using Excel™ for Windows™ on the PC
- MyNabertherm App for online monitoring of the firing on mobile devices for free download



Chamber furnace N 1491/S in production

Additional Equipment

- Other temperatures on request
- SiC plates to protect the wall heating elements
- Electro-hydraulic lift door for models to N 951
- Protective gas ports in combination with silicone sealing of the chamber
- Protective gas boxes for heat treatment under non-flammable protective and reaction gases
- Loading devices and charging aids
- Charging grates for heavy loads
- Cooling fan in combination with motor-driven exhaust air flaps in the top of the furnace
- Commissioning of the furnace with test firing and temperature uniformity measurement using 11 thermocouples including record of the measurement results
- Furnace chamber with optional heating elements in the ceiling when used for preheating of sheetmetal plates



Furnace to preheat the press ram of a hot forging plant

Model	Tmax °C	Inner dimensions in mm			Volume in l	Outer dimensions ² in mm			Heating power in kW ¹	Electrical connection*
		w	d	h		W	D	H		
N 731	1200	750	1300	750	730	1800	2400	2890	70	3-phase
N 761	1200	800	1900	500	760	1740	2700	2650	70	3-phase
N 891	1200	800	1400	800	890	1740	2200	3450	70	3-phase
N 951	1200	1000	1900	550	950	2060	2700	2780	70	3-phase
N 1296	1200	1800	1200	600	1296	2860	2000	3020	70	3-phase
N 1491	1200	1660	1200	750	1490	2720	2000	3350	110	3-phase
N 1501	1200	1000	1500	1000	1500	2060	2300	3845	95	3-phase
N 1601	1200	1600	2000	500	1600	2660	2900	2900	110	3-phase
N 1760	1200	2200	1600	500	1760	3400	2500	2900	110	3-phase
N 1771	1200	1400	1400	900	1770	2460	2200	3745	110	3-phase
N 2161	1200	1700	1700	750	2160	2760	2600	3350	110	3-phase
N 2201	1200	1000	2200	1000	2200	2060	3000	3845	150	3-phase
N 2251	1200	2500	1500	600	2250	3560	2300	3020	110	3-phase
N 2401	1200	2500	1200	800	2400	3560	2000	3445	110	3-phase

¹Depending on furnace design connected load might be higher

²External dimensions vary when furnace is equipped with additional equipment. Dimensions on request.

*Please see page 88 for more information about supply voltage

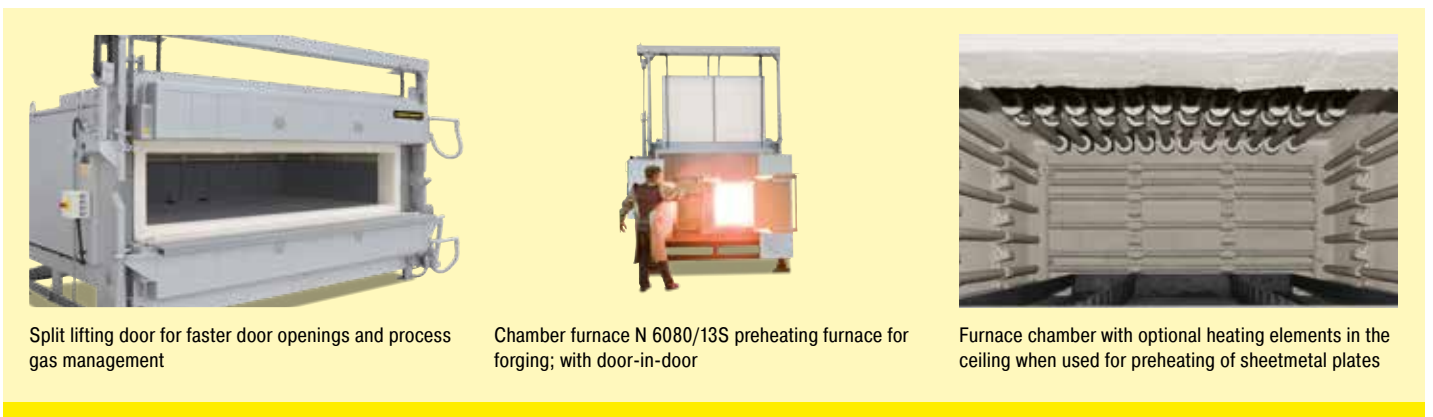

Split lifting door for faster door openings and process gas management

Chamber furnace N 6080/13S preheating furnace for forging; with door-in-door

Furnace chamber with optional heating elements in the ceiling when used for preheating of sheetmetal plates

Bogie Hearth Furnaces electrically heated

For annealing and hardening of large parts, e. g. heavy casted parts or tool steel dies to temperatures between 800 °C and 1100 °C, we recommend our bogie hearth furnaces with radiation heating. The bogie can be loaded outside the furnace. Due to the electro-hydraulic lift door and a motorized bogie (from model WS 2200/..), the furnace can be opened while hot and the load can be removed for cooling or quenching. When several bogies are used together with a second door or bogie transfer system, one bogie can be loaded outside the furnace while the other bogie is in the furnace. This shortens process times and the residual energy of the furnace can be used when the new charge is heated.



Bogie hearth furnace WS 2200/12

Standard Equipment

- Tmax 1000 °C or 1200 °C
- Dual shell housing provides low shell temperatures
- Electro-hydraulic lift door
- Heating from five sides (four sides and bogie) provides for a optimum temperature uniformity
- Bogie heating receives power via blade contacts when driven in
- Heating elements mounted on support tubes provide for free radiation and long service life
- Bottom heating protected by SiC tiles on the bogie providing level stacking surface
- Bogie with flanged wheels on rails, from model WS 2200/.. incl. electric drive
- Motorized exhaust air flap on the furnace roof
- NTLog Basic for Nabertherm controller: recording of process data with USB-flash drive
- Controller with touch operation P570 (50 programs with each 40 segments), controls description see page 84
- Freeware NTEdit for convenient program input via Excel™ for Windows™ on the PC
- Freeware NTGraph for evaluation and documentation of firings using Excel™ for Windows™ on the PC
- MyNabertherm App for online monitoring of the firing on mobile devices for free download



Bogie hearth furnace WS 1500/14S with rotary table

Additional Equipment

- Electric chain-driven bogie in combination with rail operation for smooth movement of heavy loads for models WS 1000/.. and WS 1500/..
- Bogie running on steel wheels with gear rack drive, no rails in front of the furnace necessary
- Different possibilities for an extension to a bogie hearth furnace plant:
 - Additional bogies
 - Bogie transfer system with parking rails to exchange bogies running on rails or to connect multiples furnaces
 - Fully automatic control of the bogie exchange
- Uncontrolled or controlled cooling system with frequency-controlled cooling fan and motor-driven exhaust air flap
- Multi-zone control adapted to the particular furnace provides model for optimal the temperature uniformity
- Temperature uniformity measurement



Bogie hearth furnace WS 2200/10 with electrohydraulic lift door and electric bogie hearth drive

Model	Tmax °C	Inner dimensions in mm			Volume in l	Outer dimensions ² in mm			Heating power in kW ¹	Electrical connection*	Max. charging weight in kg
		w	d	h		W	D	H			
WS 1000/10	1000	800	1600	800	1000	1470	2390	1920	60	3-phase	840
WS 1500/10	1000	900	1900	900	1500	1570	2690	2020	80	3-phase	1190
WS 2200/10	1000	1000	2200	1000	2200	1670	2990	2120	105	3-phase	1600
WS 4000/10	1000	1200	2800	1200	4000	1870	3590	2320	135	3-phase	2600
WS 7500/10	1000	1500	3600	1400	7500	2170	4390	2520	200	3-phase	4420
WS 12000/10	1000	1700	5000	1400	12000	2370	5790	2520	300	3-phase	7200
WS 15000/10	1000	2000	5000	1500	15000	2670	5790	2620	415	3-phase	8640
WS 1000/12	1200	800	1600	800	1000	1470	2390	1920	80	3-phase	840
WS 1500/12	1200	900	1900	900	1500	1570	2690	2020	105	3-phase	1190
WS 2200/12	1200	1000	2200	1000	2200	1670	2990	2120	135	3-phase	1600
WS 4000/12	1200	1200	2800	1200	4000	1870	3590	2320	200	3-phase	2600
WS 7500/12	1200	1500	3600	1400	7500	2170	4390	2520	300	3-phase	4420
WS 12000/12	1200	1700	5000	1400	12000	2370	5790	2520	415	3-phase	7200
WS 15000/12	1200	2000	5000	1500	15000	2670	5790	2620	470	3-phase	8640

¹Depending on furnace design connected load might be higher

²External dimensions vary when furnace is equipped with additional equipment. Dimensions on request.

*Please see page 88 for more information about supply voltage



Exclusive use of insulation materials without categorization according to EC Regulation No 1272/2008 (CLP)

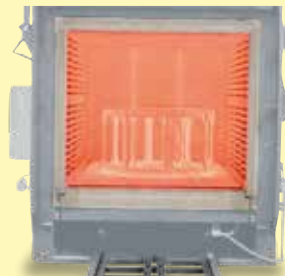

Bogie hearth furnace WS 6340S



Bogie running on steel wheels with gear rack drive, no rails necessary

Gas-Fired Bogie Hearth Furnaces up to 1400 °C for heat treatment in air or under reducing atmosphere

Gas-fired bogie hearth furnaces distinguish by their unique efficiency. The use of high-speed burners allows for short heating times. The burners are arranged according to the furnace geometry providing for a optimum temperature uniformity. Depending on the furnace dimensions, the burners can alternatively be equipped with recuperator technology to save energy. The high-quality, long-life fiber insulation, classified as non-carcinogenic, with storage capacity provides for short heating and cooling times.



Bogie hearth furnace WB 14880S

Standard Equipment

- Tmax up to 1400 °C, depending on furnace design
- Powerful, sturdy high-speed burner with special flame control in the furnace chamber provide for optimum temperature uniformity
- Operation with city gas, natural gas or liquified gas
- Fully automatic PLC control of the temperature as well as monitoring of the burner function
- Reduction-resistant fiber insulation with low heat storage provides for short heating and cooling times.
- Dual shell housing provides for low outside temperatures
- Exhaust hood with fittings for further discharge of the exhaust gases



Combi furnace plant consisting of one gas-fired bogie hearth furnace WB 11000/HS and two additional bogies incl. bogie transfer system and incl. necessary park rails

Additional Equipment

- Automatic lambda control to set the furnace atmosphere
- Exhaust air and exhaust gas piping
- Recuperator burners utilizing part of the waste heat in the exhaust tract to preheat the combustion air and considerably contribute to energy saving
- Thermal exhaust cleaning systems
- Other additional equipment for bogie hearth furnaces see pages 52



Furnace chamber with eight high-speed burners



Bogie hearth furnace WB 4000/70AS with door as heat shield

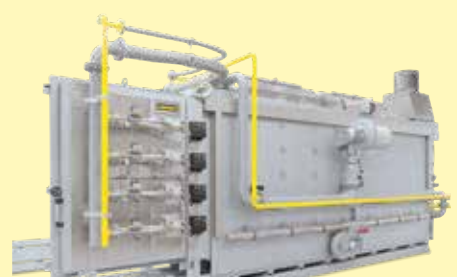

Optimum temperature uniformity due to flame entry in door and rear wall

Chamber Furnaces gas-fired

Certain heat treatment processes require a gas-fired chamber furnace. Short heating times due to the high power are a convincing argument. The chamber furnaces, equipped with powerful, fully automatic burners, cover a wide variety of these processes and can be upgraded with other useful accessories depending on the equipment.



Chamber furnace NB 4330/S

Standard Equipment

- Tmax 1300 °C
- Powerful, fully automatic burners according to industry standard for operation with natural gas (min. 9.9 kWh/m³) or propane gas. Required flow pressure under full load min. 45 mbar.
- Depending on the application, special positioning of the gas burners with flame guidance provides for optimal temperature uniformity
- Fully automatic temperature control
- Gas fittings with gas pressure control and safety line
- Multi-layer, reduction-proof insulation with light-weight refractory bricks and special back-up insulation result in low gas consumption
- Self-supporting and robust ceiling, bricks laid in arched construction
- Exhaust hood



Chamber furnace NB 361/S

Additional Equipment

- Fan burner with fully automatic control
- Indirect gas firing with radiation tubes for flame protection of the charge
- Exhaust air and exhaust gas piping
- Thermal or catalytic exhaust cleaning systems
- Recuperator technology for heat recovery see page 81



Gas stretch with two burners in the back wall of the furnace



Compact burners for standard models up to NB 600



Indirect gas firing with radiation tubes

Top Hat Furnaces or Bottom Loading Furnaces with Wire Heating up to 1400 °C

Top hat furnaces and bottom loading furnaces have the advantage that they are highly accessible for charging. The heating from all four sides and the table provides for very uniform temperatures. The basic furnace is equipped with a fixed table under the top hat. The system can be expanded by adding one or several exchangeable tables which can be driven manually or motorically. Another option is to remove the top hat completely with a shop crane. In such cases, the furnace heating system has a plug-in power supply.



Bottom loading furnace H 1000/LB



Production plant, consisting of 3 top hat furnaces HAS 1560/95S with sealed housing for operation with nitrogen. Including air/gas heat exchanger for reduced cooling times

Standard Equipment

- Tmax 1280 °C
- Dual shell housing with rear ventilation, provides for low shell temperatures
- Top hat furnaces (model LT): electrohydraulically driven top hat with fixed table
- Bottom loading furnaces (model LB): driven table and fixed top hat
- Five-sided heating from all four sides and from the table provides for a temperature uniformity up to ± 10 °C according to DIN 17052-1 see page 94
- Heating elements mounted on support tubes provide for free radiation and long service life of the heating wire
- Bottom heating protected by SiC tiles which provide for a level stacking surface
- Multi-layer insulation consisting of lightweight refractory bricks backed by special insulation
- Long-life ceiling design with fiber insulation
- Automatic exhaust air flap on the furnace roof
- NTLog Basic for Nabertherm controller: recording of process data with USB-flash drive
- Controller with touch operation C540 (10 programs with each 20 segments), controls description see page 84
- Freeware NTEdit for convenient program input via Excel™ for Windows™ on the PC
- Freeware NTGraph for evaluation and documentation of firings using Excel™ for Windows™ on the PC
- MyNabertherm App for online monitoring of the firing on mobile devices for free download

Additional Equipment

- Tmax to 1400 °C
- Cooling system with fresh air fan for rapid cooling
- Sides with fiber insulation to reduce cycle times
- Fabric cover on the fiber roof (and sides) to reduce fiber dust
- Protective gas connection for purging the furnace with non-flammable protective or reaction gases
- Automatic gas supply systems
- Multi-zone control adapted to the particular furnace provides model for optimal temperature uniformity
- Commissioning of the furnace with test firing and temperature uniformity measurement (also with load) for the purpose of process optimization
- Additional tables, table changing system, also motorized
- Exhaust air and exhaust gas piping



Top hat furnace H 3070/S for loading and unloading from the front and rear side.

Model	Tmax °C	Inner dimensions in mm			Volume in l	Outer dimensions ² in mm			Heating power in kW ¹	Electrical connection*	Weight in kg
		w	d	h		W	D	H			
H 125/LB, LT	1280	800	400	400	125	1550	1500	2200	12	3-phase	1250
H 250/LB, LT	1280	1000	500	500	250	1530	1700	2300	18	3-phase	1400
H 500/LB, LT	1280	1200	600	600	500	2020	1800	2500	36	3-phase	1800
H 1000/LB, LT	1280	1600	800	800	1000	2200	2000	2900	48	3-phase	2800
H 1350/LB, LT	1280	2800	620	780	1360	3750	2050	3050	75	3-phase	3500
H 3000/LB, LT	1280	3000	1000	1000	3000	4000	2100	3200	140	3-phase	6200

¹Depending on furnace design connected load might be higher

²External dimensions vary when furnace is equipped with additional equipment. Dimensions on request.

*Please see page 88 for more information about supply voltage



Top hat furnace plant with three exchangeable tables and protective gas boxes for heat treatment

Top hat furnace system H 245/LTS with cooling station and table changing system

Top hat furnace H 500/LT with manual table exchange system for two tables

Furnaces for Continuous Processes

Continuous furnaces with a conveyor system through the furnace are used in particular when the same processes are repeated, large quantities have to be heat treated or automation is required. When designing the right flow system, parameters such as working temperature, charge dimensions, weight and throughput play an important role.

The following pages of this chapter describe options based on different conveying concepts and types of heating for continuously implementing heat treatment processes. Furnace concepts for processes that require a protective gas or hydrogen atmosphere are described in our catalog "Thermal Process Technology 2, furnaces and heat treatment plants for processes under protective or reaction gases or in vacuum".

The following equipment applies to all furnaces in this chapter:



Over-temperature limiter with adjustable cutout temperature as temperature limiter to protect the furnace and load



Exclusive use of insulation materials without categorization according to EC Regulation No 1272/2008 (CLP). This explicitly means that alumino silicate wool, also known as "refractory ceramic fiber" (RCF), which is classified and possibly carcinogenic, is not used.



Defined application within the constraints of the operating instructions



Controller with intuitive touch operation



As additional equipment: Process control and documentation via VCD software package for monitoring, documentation and control

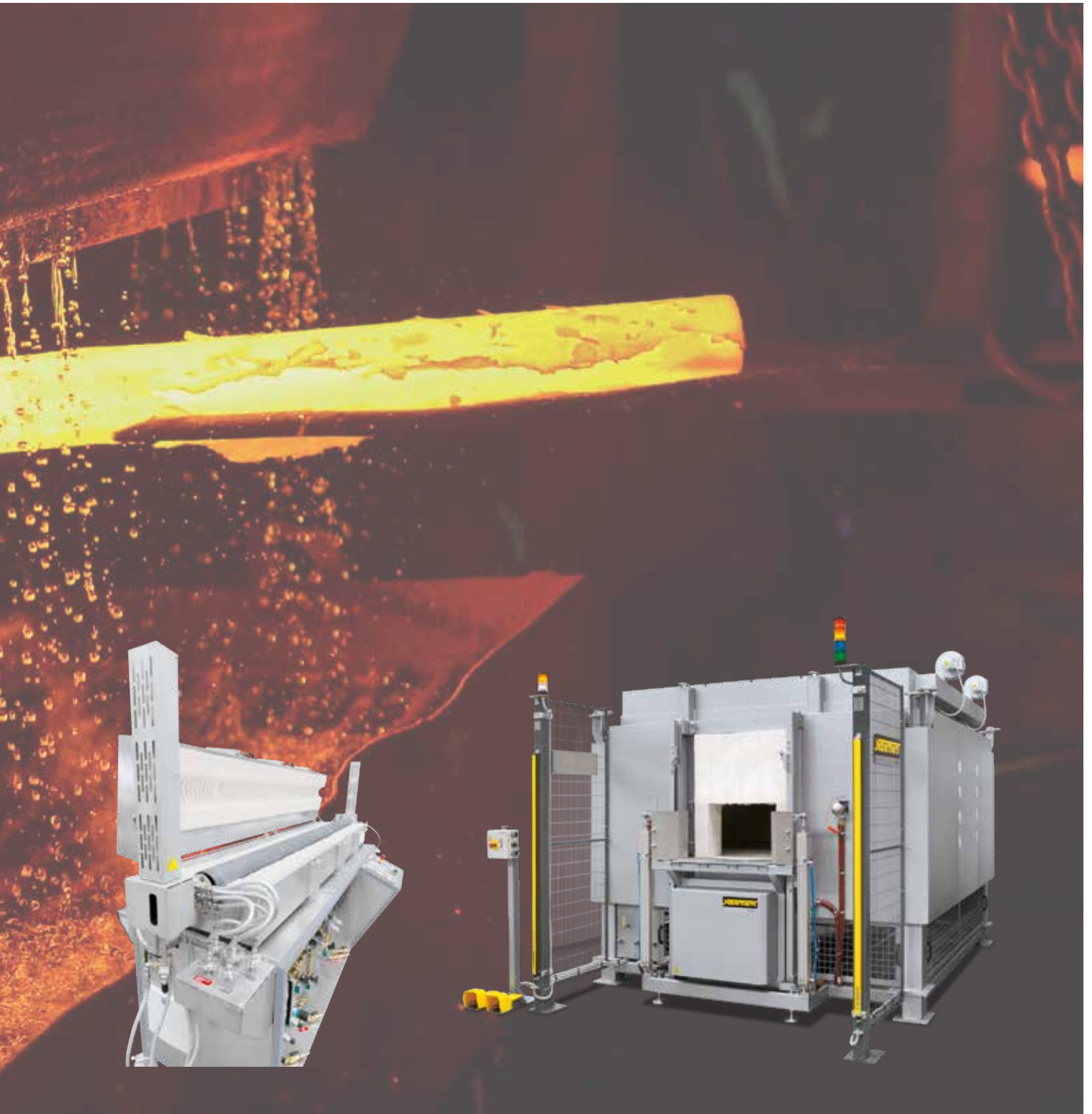

Furnace Group	Model	Page
Rotary hearth furnaces up to 1300 °C with and without air circulation	DH	60
Continuous furnaces	D	62
Wire and strand annealing furnaces	D .. S	65

Rotary Hearth Furnaces up to 1300 °C with and without Air Circulation electrically heated or gas-fired

The rotary hearth furnaces of the DH product line are optimally suited for continuous processes on a small floor space. They are designed for preheating processes such as the preheating of metal parts for forging or for preheating of moulds. Charging and discharging can be done at one position – either by a person or fully automatic. The hearth rotates in pre-set segments individually reconciled with the workpart geometry. The rotational speed and rotational intervals can be defined by the control system or by manual switching.

The rotary hearth furnaces are specifically designed for the required throughput and charge dimensions. They are heated electrically or alternatively gas-fired by means of powerful gas burners. Subject to the temperature range these rotary hearth furnaces are equipped with or without air circulation.



Electrically heated rotary hearth furnaces with Tmax 450 °C, prepared for automatic operation

Standard Equipment

- Tmax 1300 °C
- Tmax > 850 °C up to 1300 °C with radiation heating
- Tmax up to 850 °C with powerful air-circulation for better heat transmission onto the charge and to optimize the temperature uniformity in the low-temperature range
- Electrically heated:
 - Wire heating elements in the furnaces ceiling
 - Heating via SiC rods installed in the furnace ceiling for furnaces up to 1300 °C
- Gas-fired:
 - Directly gas-fired: The burner fires directly in the furnace chamber
 - Indirectly gas-fired: The burner fires in a radiation tube to avoid a direct contact between the charge and the burner exhaust gases
- Very compact design compared with continuous furnaces
- Designed for continuous operation at one working temperature
- Table diameter up to 6000 mm
- Additional water sealing between the rotary table and the housing for forced convection furnaces and directly gas-fired furnaces
- Table drive under the furnace provides for movement in defined segments or continuously
- Low-vibration movement of the rotary hearth
- Charging through a lift-door
- Actuation of rotary drive via foot pedal or external contact in case of automatic operation
- Additional service door on request



Electrically heated rotary hearth furnace with Tmax 1300 °C according to AMS2750F





Directly gas-fired rotary hearth furnace with T_{max} 1100 °C for preheating of molds



Pre-heating of steel rings for forging in a rotary hearth furnace

Additional Equipment

- Exhaust hood above the door opening for discharge of the warm exhaust air when door is open
- Charging aids for ease of loading and unloading
- Multi-zone control for uniform thermal profile during the cycle
- Protective gas connections
- Visualization of loaded positions on the human machine interface (HMI)



Gear rim drive under the rotary hearth furnace



Exhaust hood above charging opening



Rotary table with fire-resistant concrete plates to protect the insulation

Continuous Furnaces

electrically heated or gas-fired

Continuous furnaces are the right choice for processes with fixed cycle times such as drying or preheating, curing, aging, vulcanisation or degassing. The furnaces are available for various temperatures up to a maximum of 1100 °C. The continuous furnaces of the DF model series are also specially designed for ceramic thick-film processes for burning out (Burn-Out) and firing/sintering (Fire) functional layers for example in LTCC applications. The furnace design depends on the required throughput, the process requirements for heat treatment and the required cycle time.

The conveyor technology is tailored to the required working temperature, geometry and weight of the charge and to the requirements regarding available space and integration into the process chain. The conveyor speed and the number of control zones are defined by the process specifications.



Heat treatment plant D 1600/6100/800/26AS according to EN 1539 with cooling station KS 1600/6100/800/AS for vulcanization processes of hoses

Conveyor Concepts

- Conveyor belt
- Metal conveyor belt with adjusted mesh gauges
- Drive chain
- Roller conveyors
- Paternoster
- Pusher-type
- Rotary hearth

Heating Systems

- Electric heating, radiation or convection
- Direct or indirect gas-fired
- Heating with the use of external heat sources

Temperature Cycles

- Control of working temperature across the whole length of the furnace, such as for drying or preheating
- Automatic control of a process curve applying defined heat-up, dwell and cooling time
- Heat treatment including a final quenching of the charge

Process Atmosphere

- In air
- For processes with organic outgasings incl. mandatory safety technology according to EN 1539
- In non-flammable protective or reactive gases such as nitrogen, argon or forming gas
- In flammable protective or reactive gases such as hydrogen incl. the necessary safety technology



Roller continuous furnace N 650/45 AS for heat treatment of heavy workparts



Continuous furnace DF 36/320/5/10WK for burnout and firing/sintering in LTCC applications



Continuous belt furnace D 1000/4000/140/35 AS for black wash drying on sand cores

Basic Configuration Criteria

- Conveyor speed
- Temperature uniformity
- Operating temperature
- Process curve
- Work space width
- Charge weights
- Cycle time or throughput
- Length of charge and discharge zone
- Generated exhaust gases
- Specific industry standards such as AMS2750G, CQI-9, FDA etc.
- Other individual customer requirements



Pusher-type furnace system D 520/2600/55-04 S to sinter teflon coatings under protective atmosphere



Continuous furnace D 700/10000/300/45S with chain conveyor for 950 °C, gas-fired



Continuous furnace D 1500/3000/300/14 for thermal ageing with mesh belt transport system and subsequent cooling station



Mesh belt drive in a continuous furnace



Continuous furnace for bulk materials in baskets



Continuous furnace D 1000/1250/200/26AS for tempering of injection molded parts

Wire and Strand Annealing Furnaces

These models are particularly suitable for continuous heat treatment at operation temperatures up to 1200 °C. The modular design allows adjustment to different length and width requirements. The heating elements are mounted on only one side of the furnace and can be changed individually during operation. Optimum temperature uniformity is achieved by means of a multiple zone control system tailored to the furnace dimensions.



Standard Equipment

- Tmax 1200 °C
- Modular design, variable length
- Small outer dimensions due to efficient microporous silica insulation
- Special heating elements that can be changed during operation
- Heating from the ceiling
- Optimum temperature uniformity by means of multiple zone control

Additional Equipment

- Gas supply systems for the working tubes for non-flammable or flammable protective or reaction gases including hydrogen, with burn off torch and safety technology
- Process and charge documentation
- Double chamber furnace system with parallel chambers for simultaneous operation at different temperatures

Wire annealing furnace based on a tube furnace with safety package for hydrogen as process gas



Strand annealing furnaces based on a tube furnace with a length of 6 meters



Strand annealing furnace D 390/S



D 250/S in production

Tempering Plants for Aluminum and Steel

Nabertherm offers different plant concepts for tempering. Thanks to a modular structure, our systems can be optimally adapted to the process requirements or charge size. The systems can be designed from manual charging to fully automatic process flow.

Nabertherm also offers customized solutions for the process documentation, which is becoming increasingly important today, from the standard recording of the furnace chamber temperature to the complete documentation of the heat treatment process including the documentation of the quenching delay time according to e.g. AMS2750F or the CQI-9.

The following equipment applies to all furnaces in this chapter:



Over-temperature limiter with adjustable cutout temperature as temperature limiter to protect the furnace and load



Exclusive use of insulation materials without categorization according to EC Regulation No 1272/2008 (CLP). This explicitly means that alumino silicate wool, also known as “refractory ceramic fiber” (RCF), which is classified and possibly carcinogenic, is not used.



Defined application within the constraints of the operating instructions



Controller with intuitive touch operation



As additional equipment: Process control and documentation via VCD software package for monitoring, documentation and control



Furnace Group	Page
Tempering plants	68
Drop-bottom furnaces/vertical tempering plants	69
Customized solutions	72
Horizontal tempering plants	74
More tempering plant concepts	76
Quench tanks	77

Tempering Plants



Tempering plants are used for processes such as T6-heat treatment of aluminum (solution annealing, quenching and artificial aging) or steel hardening. By using one or more furnaces in combination with a quench tank or cooling station, the tempering process can be carried out manually, semi-automatically or fully automatically.

Recording the process data plays an important role when choosing a tempering plant. A distinction is made between simple recording of the furnace temperature and automatic recording of all process data, such as process times, water tank temperature and transfer time to the quenching medium. And all of this while taking into consideration relevant automotive and aviation standards, such as CQI-9, AMS2750F. The movement technology is a major distinguishing feature with regard to the different tempering plant concepts. A distinction is made between horizontal and vertical transfer of the charge. The decision as to which drive concept to choose can be based on various reasons, such as the transfer time or the working temperature. Automated tempering plants are available in different formats. As well as the standard models, customized plants with several holding positions and furnace chambers can also be fully automated.

Some major distinguishing features of horizontal and vertical systems are described below. With horizontal tempering plants, the quench tank is positioned in front of the chamber furnace. The charge is transferred to the furnace horizontally with a two-axis manipulator and, after the heat treatment process, is removed while still hot and then quenched. Since, with this plant concept, the movement technology is only in the hot furnace for a short time, temperatures up to 1300 °C are possible. With drop-bottom furnaces, the quench tank is positioned below the furnace chamber. This plant concept enables the fastest transfer times and, because of this, is especially suitable for thin-walled components. These plant concepts are described in detail on the following pages.

Design Features of Horizontal and Vertical Systems

	Horizontal Tempering Plant	Drop-Bottom Furnace Plant/Vertical Tempering Plant
Transfer time (depends on weight of charge)	> 7 s	< 7 s
Temperature	80 °C to 1300 °C	80 °C to 600 °C
Atmosphere	Air and protective gas	Air
Typical applications	Light metals and steel	Light metals

Drop-Bottom Furnaces/Vertical Tempering Plants

Drop-bottom furnaces are used for solution annealing and subsequent rapid quenching of aluminum alloys. In particular, with thin-walled aluminum components, quench delay times of just five seconds from when the door begins to open until complete immersion in the quench tank are possible depending on the plant concept and size. Generally, these requirements can be met only with this furnace design. The drop-bottom furnace stands on a base so that a quench tank can be positioned directly below the furnace. For the quenching process, the door moves horizontally to the side and a basket containing the components is lowered into the quench tank by means of a lifting device that is integrated in the furnace. The conveying technology can be controlled automatically or semi-automatically.

Because of the broad working temperature range, drop-bottom furnace plants allow complete T6-heat treatments, consisting of solution annealing, quenching, and artificial aging in just one furnace. If required, the artificial aging can also take place in a separate furnace outside the system.

Drop-Bottom Furnace Plants Variants (for Further Details See Page 70 ff.)

Variant A



Quench tank fixed under the drop-bottom furnace. Loading takes place manually on a grate between the furnace and the tank. Semi-automatic process.

Variant B



Drop-bottom furnace plant with quench tank on rails and holding positions for fully automatic processes with transfer time up to five seconds.

Variant C



Drop-bottom furnace plant with quench tank built into the floor for low buildings (fully automated as an option).

Model	Tmax °C	Inner dimensions in mm			Max. charging weight in kg	Height with quench tank on the floor	Height with quench tank on a bogie	Heating power in kW ¹
		w	d	h		in mm	in mm	
FS 1200/60A	600	600	600	1000	150	4870	4200	36
FS 4000/60HA	600	1100	1100	1100	350	7300	5700	96
FS 5600/60A	600	1400	1400	1100	1200	7300	5700	120

¹Depending on the furnace design, connected load might be higher

Here you can watch a product video of the drop-bottom plant system for solution annealing of aluminum aviation parts:



Standard Equipment Drop-Bottom Furnace Plants

- Installed on a frame
- Working temperature range between 80 °C and 600 °C
- Electrically heated
- Air flow, depending on space conditions and charge geometry, horizontal or vertical
- Siemens PLC controls with touchpanel as operating interface

Standard Design Variant A

This is the least expensive and most space-saving variant and offers the following features:



Drop-bottom furnace plant with fixed quench tank (variant A)

Loading

- The charge is loaded onto the charge carrier, which is above the quench tank in the plant, with a forklift truck
- Fastest quench delay time in seven seconds

Quench Tank

- Fixed, below the furnace
- Tank with circulation, fresh water cooling, level control and temperature monitoring

Standard Design Variant B

Equipment, see variant A, but lower construction height with movable platform bogie with loading space and water tank.



Fully automatic drop-bottom furnace plant with unloading crane (variant B)

Loading

- The charge is loaded onto a holding position which is on a bogie on rails
- The bogie is then moved beneath the furnace and the furnace loading system picks up the charge carrier
- Fastest quench delay time in five seconds

Quench Tank

- The quench tank and basket position are installed together on a bogie
- After loading is complete, the bogie is moved beneath the furnace. The charge is lowered automatically into the tank for quenching.
- Due to the low height, this plant concept allows the fastest quench times of just five seconds

Standard Design Variant C

Equipment, see variant A, but lower construction height with water tank built into the floor.



Drop-bottom furnace FS 5670/60AS with quench tank built into the floor (variant C)

Loading

- The charge is loaded onto a holding position which is on a bogie on rails
- The bogie is then moved beneath the furnace and the furnace loading system picks up the charge carrier
- When the charge is in the furnace, the bogie is moved again to the position beside the furnace
- Fastest quench delay time in seven seconds

Quench Tank

- The quench tank is built into the floor

Extension Options for all Variants

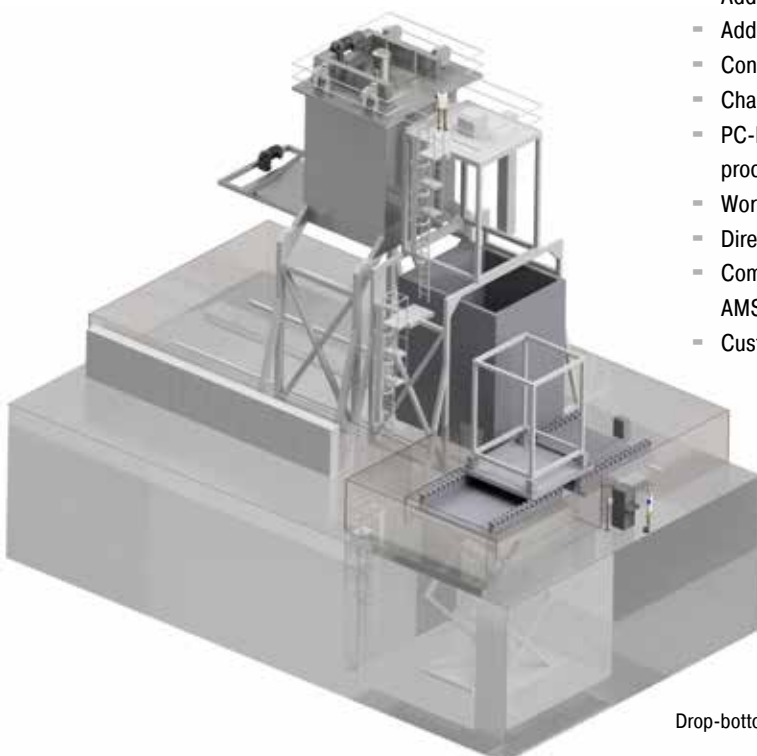

Drop-bottom furnace FS 56000/AS with water tank WAB 65000

- Automatic mode
- Additional furnaces for alternating operating with several baskets
- Additional parking positions
- Controlled cooling of the furnace with fresh-air fan
- Charging baskets
- PC-based software, Nabertherm Control Center, for visualization, control and process documentation
- Working temperature can be extended to 650 °C
- Direct or indirect gas heating as alternative to electric heating
- Compliance with relevant aviation and automotive standards, such as AMS2750F, AMS2770/2771 or CQI-9 as an option
- Customized extensions

Customized Solutions



Concepts where the drop-bottom furnace moves on a portal can also be implemented. This design allows especially compact plant sizes. The baskets are placed directly below the portal, which means a significant reduction in the required set-up area. The drop-bottom furnace moves to the holding position and lifts the basket with the furnace lifting system. After quenching, the basket is taken over by the unloading crane installed on the side of the furnace and is then either taken back to the holding position or is charged for the following artificial aging in the top-loading furnace.



Movable drop-bottom furnace for solution annealing with pit-type furnace for artificial aging with four holding positions

Here you can watch the product video for a quenching and tempering plant for aluminum:





Fully automatic drop-bottom furnace plant, consisting of two drop-bottom furnaces, movable water bath and several loading and unloading positions

The modular setup of our systems allows for various different plant design options and with the corresponding planning the possibility of extension at a later date.

Plants with two or more furnaces have the benefit that solution annealing and artificial aging can be carried out directly in the plant in separate furnaces. This reduces waiting times and energy losses that would otherwise occur when the working temperature in the furnace is changed. With specialized solution annealing and artificial aging furnaces it is also often practical to design all furnaces for 600 °C in order to achieve maximum flexibility. For optimum utilization of plants such as this, also with unmanned operation, such as overnight or at the weekend, more holding positions to buffer several charging baskets can be installed. These holding positions can be processed by the system one after the other without any external intervention. The Nabertherm Control Center offers many different customized options, such as aggregating reports of solution annealing and artificial aging, integrated process documentation, blocking individual furnaces or holding positions, barcode entry with allocation and checking functions, and data exchange with external systems.

Here you can watch the product video for a fully automatic tempering plant for aluminum with two FS 5350/60AS drop-bottom furnaces:



Horizontal Tempering Plants

Because the design of drop-bottom furnaces limits their maximum temperature to 600 °C, different plant concepts are needed to temper materials, such as steel, where much higher temperatures are required.

For these processes, horizontal chamber furnaces, which are loaded from the front by a two-axis manipulator, are suitable. This type of plant is characterized by a low construction height and a low level of wear and tear, as the movement technology is in the hot zone only for a short time. Depending on the charge weight and dimensions, these systems allow quench delay times of seven seconds. Consequently, in many cases, horizontal tempering plants with a forced convection furnace are also very good for heat treatment of aluminum.

Nabertherm offers a wide range of standard sizes on which manual, semi or fully automatic horizontal tempering plants can be developed.



Horizontal tempering plant with forced convection furnace, two-axis manipulator and water quench bath

Standard Equipment

- Working temperature range between 80 °C and 1300 °C
- Quench tank with circulation, fresh water cooling, level control and temperature monitoring
- Two-axis manipulator with fork for semi-automatic charging, removing and quenching the charge
- Siemens S7 PLC controls with touchpanel as operating interface
- Electrically heated

Additional Equipment

- Controlled cooling of the furnace with fresh-air fan
- Direct or indirect gas firing
- Charging basket made from normal or stainless steel
- Three-axis manipulator for charging in additional furnaces or tanks (for example, cleaning tanks) or for transferring to possible holding positions
- PC-based software, Nabertherm Control Center, for visualization, control and process documentation
- Compliance with relevant aviation and automotive standards, such as AMS2750F, AMS2770/2771 or CQI-9 as an option
- Customized extensions

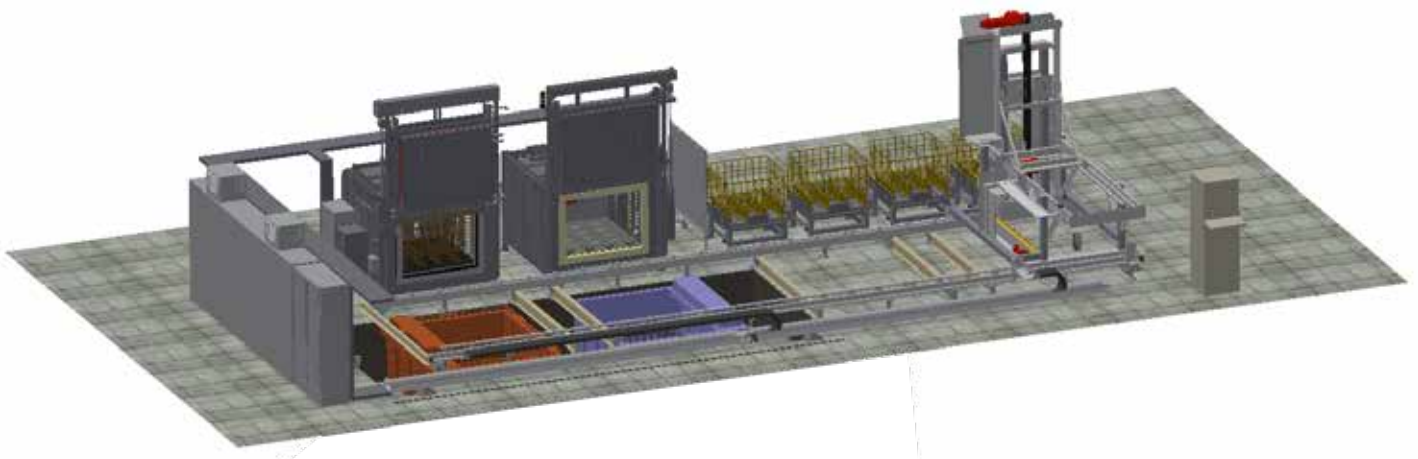

Fully automatic tempering plant with two chamber furnaces, quench tank, cleaning tank, conveying technology and holding positions for four charging baskets



Fully automatic tempering plant comprising an annealing furnace, a water quench tank, and a two-axis manipulator

As these plants can be easily extended, full automation is possible. By extending the conveying technology with a third axis for sideways movement, several furnaces, tanks and holding positions can be combined automatically. Plants can be adapted to suit specific processes. Upstream conveying systems can also be integrated. The plants can be loaded and unloaded easily using the integrated holding positions.

Furnace families	Model	Tmax °C	Work space dimensions in mm			Volume in l	Typical application	Quenching bath
			w	d	h			
Forced convection chamber furnaces	NA 120/.. - N 4000/..	450, 600 or 850	450 to 2000	600 to 2500	450 to 2000	120 to 4000	Light metals	Individually adapted to suit the respective process and size of charge
Radiation heated chamber furnaces	N 161/.. - N 2401/..	1300	750 to 2500	1300 to 1200	750 to 700	161 to 2401	Steel and titanium	



Semi-automatic tempering plant for aluminum



Fully automatic tempering plant for glass



Fully automatic tempering plant for steel

More Tempering Plant Concepts

Bogie hearth furnaces, pit-type furnaces and also top hat furnaces are suitable for processes in which heavy and thick-walled components are heat treated and where quench delay times are not especially critical. The furnace is loaded and the hot charge is transferred to the quenching medium with a crane or forklift truck. The bogie of a bogie hearth furnace is loaded outside the furnace. When the design includes an electro-hydraulic lift door and a motorized bogie, the furnace can be opened while hot and the load can be removed for cooling or quenching.

Top hat furnaces, which allow a very compact design, are an alternative to bogie hearth furnaces. The top hat creates a very good seal with the movable table, which is a requirement for good temperature uniformity and energy efficiency. As the table moves to the side, this allows convenient loading. Especially sensitive charges can be loaded beneath the top hat and do not have to be moved much more.

If the components are high, pit-type furnaces are suitable for heat treatment. These furnaces can be opened at high temperatures and the charge is then transferred to the quench tank by a crane.

Many heat treatment processes for metals generally take place in protective or reaction gases or in vacuum to prevent or minimize oxidation of the components. Heat treatment systems for these processes can be found in our catalog "Thermal Process Technology 2, furnaces and heat treatment plants for processes under protective or reactive gases or in vacuum".



Tempering plant with top hat furnace H 4263/12S and water bath



Automatic tempering plant comprising a top hat furnace and two cooling top hats for forced air cooling (the second cooling top hat is on the right not in the picture) with interchangeable table system

Quench Tanks

Standard water or polymer quench tanks have a single stainless steel wall and incorporate a quenching medium circulation system for effective removal of energy from the component. Temperature and level are monitored. All tanks have connections for water feed and drainage. The tank can be cooled and the level topped up with the customer's fresh water supply.

The quench tanks are controlled with a Siemens PLC controls. The system is operated conveniently with a touchpanel or the PC-based Nabertherm Control Center software.



Combined oil quenching and cleaning bath with immersible tables, protection cover, oil separator and exhaust system

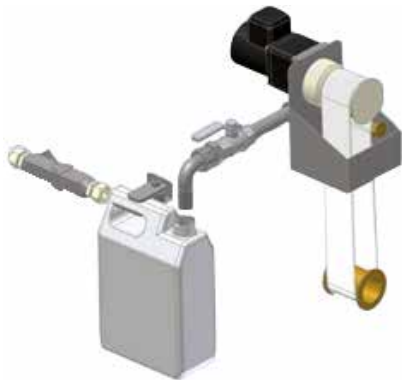

Oil separator for quench tanks with water

Additional equipment

- Quench tank in customer's pit
- Quench tank heating
- Quench tank with insulation for improved energy efficiency at higher working temperatures
- Automatic level control
- Rolling lid for the quench tank in automatic operation at higher working temperatures of the quench medium
- Active cooling system

If quenching is carried out in oil or polymer it is advisable to integrate a cleaning tank in the overall plant. Especially if the next step in the process involves tempering in a forced convection chamber furnace, the components should be clean when they are transferred to the furnace.

For heat treatment where flammable substances are released or introduced, the furnaces can be equipped with a corresponding safety system in accordance with EN 1539.

Depending on the material and the required cooling rate, the charge can also be force-cooled or quenched in an air quenching chamber.



Water quench tank WAB 24000 with forced circulation



Oil quenching bath OAB 67000 with heat exchanger and a volume of 67.000 liters oil



Oil quench tank OAB 2500/S



Powerful circulation of quenching medium

Furnaces for Special Applications





	Page
Clean room solutions	80
Energy efficiency concepts	81

Clean Room Solutions

Clean room applications impose particularly high requirements to the design of the chosen furnace. If the complete furnace is operated in a clean room an essential contamination of the clean room atmosphere must be avoided. Especially, the particle contamination must be reduced to a minimum.

The specific application determines the choice of the required furnace technology. In many cases forced convection furnaces are required to achieve the necessary temperature uniformity at lower temperatures. For higher temperatures, Nabertherm has also delivered many furnaces with radiant heating.



Hot-wall retort furnace NRA 1700/06 with charging frame for installation in grey room with charging door in clean room

Furnace Installation in the Clean Room

If the complete furnace is supposed to be positioned in the clean room, then it is important that both the furnace chamber and the furnace housing as well as the controls provide for good protection against contamination. Surfaces must be easy to clean. The furnace chamber is tightly sealed to the insulation behind it. If necessary, additional equipment such as filters for the fresh air supply or the air circulation in the furnace can be used to improve the cleanliness class. It is recommended to install the switchgear and the furnace controls outside the clean room.

Furnace Installation in the Grey Room, Furnace Charging from the Clean Room

Optimal results with respect to cleanness will be achieved by placing the furnace in the grey room with charging from the clean room. This significantly reduces the amount of costly space needed in the clean room to a minimum. The front and the furnace interior in the clean room are designed for easy cleaning. With this configuration even the highest clean room classes can be achieved.

Sluice Furnace between Grey Room and Clean Room

Logistics between clean room and grey room can often be easily sorted out. Lock furnaces with one door in the grey room and the other door in the clean room are the perfect choice for these applications. The inner chamber as well as the furnace front in the clean room will be especially designed for lowest particle contamination.



Forced convection chamber furnace NAC 250/45 with clean room specs



High-temperature furnace with loading from the clean room; switchgear and furnace installed in grey room



KTR 8000 designed as a production oven in the clean room with filters for air circulation

Energy Efficiency Concepts

In face of rising energy prices and stricter environmental regulations there is increasing demand for heat treatment plants with greater energy efficiency. Depending on the furnace size and the process there is always a certain amount of potential energy which can be recovered from the waste heat and re-used. This is especially true for large furnace systems or long process times which allow for huge energy savings that the additional investment has a short pay-back time. The thermal energy from finished charges can also be used to pre-heat cold charges which is also an efficient way of saving energy.

The following examples outline engineering alternatives for heat recovery:



Production system, consisting of four chamber furnaces for moving the load during heat treatment along with a three-stage heat exchanger to optimize energy efficiency

Heat Exchangers

The principle of the counterflow heat exchanger is to use the hot exhaust gas coming from the furnace to pre-heat the cold fresh air channelled into the furnace. In many cases, there is no need anymore for a separate fresh air preheating unit. Such a system is recommended if the process requires continuous air exchange in the furnace chamber, such as when tempering silicone, or during drying processes that are covered by the EN 1539 industrial standard.

Recuperator Burners

Large gas-heated heat treatment furnaces are especially advantageous for the installation of recuperator burners. Recuperator burners also use hot exhaust gas; to pre-heat the combustion air. Depending on the furnace model and the process, substantial energy savings of as much as 25 % can be realized by using recuperator burners so that there is a short pay-back time for the additional purchase costs.

Heat Transfer Chambers

Heat transfer chambers, which can also be described as cooling/heating chambers, offer two enormous advantages. For one, they help save energy, and for another, using a heat transfer chamber increases productivity.

The load is removed from the furnace while it is still hot and placed in the heat transfer chamber. The chamber also has room for a new, cold charge. Circulating the air cools the hot charge and, at the same time, preheats the cold charge before it is put into the furnace. Consequently, the furnace heating does not have to provide the thermal energy and through-put capacity of the furnace is increased of the same time.

The above systems for enhancing energy efficiency are only a few examples of technical alternatives.



Counterflow heat exchanger for the forced convection chamber furnace N 2560/26 ACLS



Heat transfer between a hot and a cold charge



Recuperator burner for aluminum melting furnaces 16 x TBR 110/12 and 2 x TBR 180/12

Process Control and Documentation



	Page
Nabertherm controller series 500	84
MyNabertherm app for mobile monitoring of process progress	86
Functions of the standard controllers	88
Process data storage and data input via PC	89
Process data storage – VCD-software for visualization, control and documentation	90
PLC controls	91
Process data storage for PLC controls	92
Nabertherm control center NCC	93
Temperature uniformity and system accuracy	94
AMS2750F, NADCAP, CQI-9	95

Nabertherm Controller Series 500

**I AM THE
CONTROLLER**

I'm the big brother of analog buttons and turning switches. I am the new generation of control and intuitive operation. My skills are highly complex, my operation is simple. I can be touched and speak 24 languages. I'll show you exactly which program is currently running and when it ends.



The controller series 500 impresses with its unique scope of performance and intuitive operation. In combination with the free "MyNabertherm" smartphone app, the operation and monitoring of the furnace is even easier and more powerful than ever before. The operation and programming takes place via a high-contrast, large touch panel, which shows exactly the information that is relevant at the moment.



B510, C550, P580



B500, C540, P570

Standard Equipment

- Transparent, graphic display of the temperature curves
- Clear presentation of the process data
- 24 operating languages selectable
- Consistent, attractive design
- Easily understandable symbols for many functions
- Precise and accurate temperature control
- User levels
- Program status display with estimated end time and date
- Documentation of the process curves on USB storage medium in .csv file format
- Service information can be read out via USB stick
- Clear presentation
- Plain text display
- Configurable for all furnace families
- Can be parameterized for the different processes



Highlights

In addition to the well-known and matured controller functions, the new generation offers you some individual highlights. Here is an overview of the most important ones for you:

Modern Design



Colored display of temperature curves and process data

Easy Programming



Simple and intuitive program entry via touch panel

Integrated Help Function

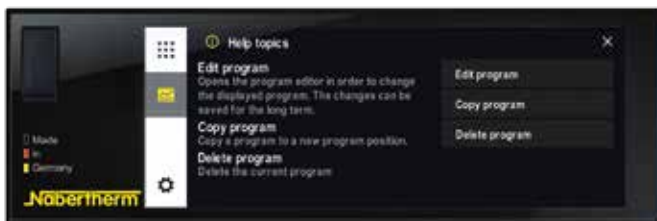

Information on various commands in plain text

Program Management



Temperature programs can be saved as favorites and in categories

Segment Player

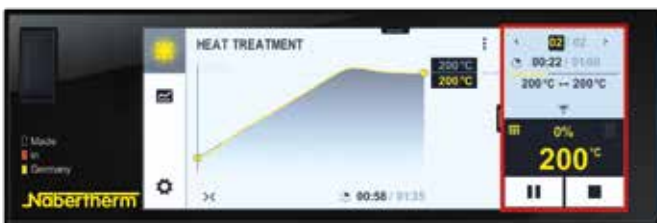

Detailed overview of process information including setpoint, actual value and switched functions

Wi-Fi-Capable



Connection with the MyNabertherm app



Intuitive touch screen



Easy program entry and control



Precise temperature control



User levels



Process documentation on USB

Further information on Nabertherm controllers, process documentation and tutorials on operation can be found on our website: <https://nabertherm.com/en/series-500>



MyNabertherm App for Mobile Monitoring of Process Progress

MyNabertherm app – the powerful and free digital accessory for Nabertherm 500 Series Controllers. Use the app for convenient online progress monitoring of your Nabertherm furnaces – from your office, while on the way or from wherever you wish. The app always keeps you in the picture. Just like the controller itself, the app is also available in 24 languages.



Convenient monitoring of one or multiple Nabertherm furnaces simultaneously



Display of program progress for each furnace



Easy to contact

App-Functions

- Convenient monitoring of one or multiple Nabertherm furnaces simultaneously
- Clear presentation as a dashboard
- Individual overview of a furnace
- Display of active/inactive furnaces
- Operating status
- Current process data

Display of Program Progress for Each Furnace

- Graphical representation of the program progress
- Display of furnace name, program name, segment information
- Display of start time, program run time, remaining run time
- Display of additional functions such as fresh-air fan, exhaust air flap, gassing, etc.
- Operating modes as symbol

Push Notifications in Case of Malfunctions and at Program End

- Push notification on the lock screen
- Display of malfunctions with an associated description in the individual overview and in a message list

Contact with Service Possible

- Stored furnace data facilitate rapid support for you

Requirements

- Connection of the furnace to the Internet via the customer's Wi-Fi
- For mobile devices with Android (from version 9) or IOS (from version 13)



Monitoring of Nabertherm furnaces with 500 series touch panel controller for Arts & Crafts, laboratory, dental, thermal process technology, advanced materials and foundry applications.

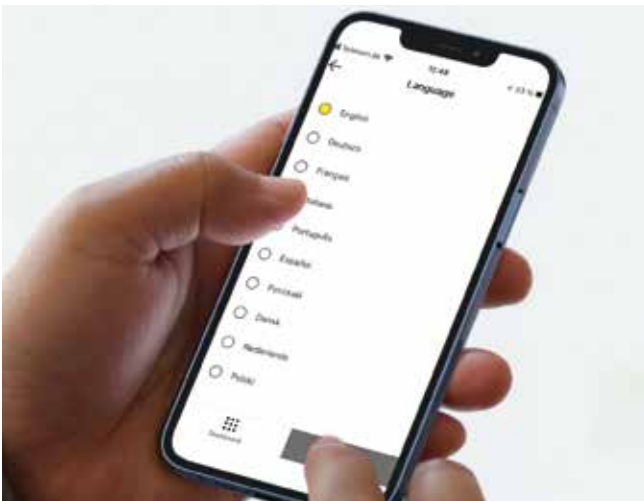

Available in 24 languages



Push notifications in case of malfunctions



Clear contextual menu

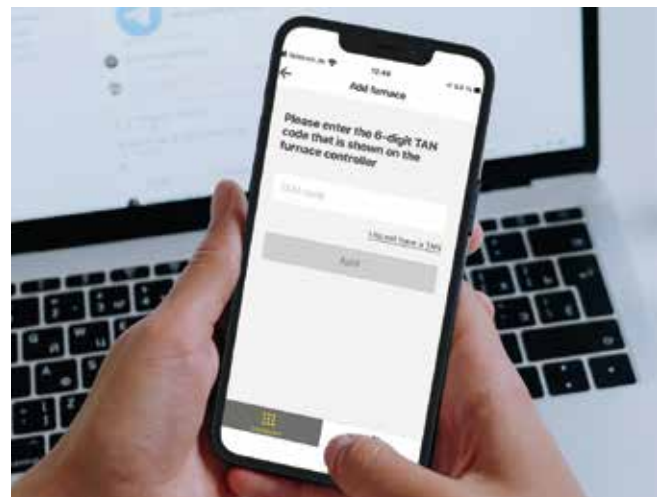

Any addition of Nabertherm furnaces

Everything on display in the new Nabertherm app for the new controller series 500. Get the most out of your furnace with our app for iOS and Android. Don't hesitate to download it now.



Functions of the Standard Controllers

	R7	3216	3208	B500/ B510	C540/ C550	P570/ P580	3508	3504	H500	H1700	H3700	NCC
Number of programs	1	1		5	10	50	1/10/ 25/50 ³	1/10/ 25/50 ³	20	20	20	100
Segments	1	8		4	20	40	500 ³	500 ³	20	20	20	20
Extra functions (e. g. fan or autom. flaps) maximum				2	2	2-6	0-4 ³	2-8 ³	3 ³	6/2 ³	8/2 ³	16/4 ³
Maximum number of control zones	1	1	1	1	1	3	2 ^{1,2}	2 ^{1,2}	1-3 ³	8	8	8
Drive of manual zone regulation				●	●	●						
Charge control/bath control						●	○	○	○	○	○	○
Auto tune		●	●	●	●	●	●	●				
Real-time clock				●	●	●			●	●	●	●
Graphic color display				●	●	●			4" 7"	7"	12"	22"
Graphic display of temperature curves (program sequence)												
Status messages in clear text			●	●	●	●	●	●	●	●	●	●
Data entry via touchpanel				●	●	●			●	●	●	●
Entering program names (i.e. "Sintering")				●	●	●				●	●	●
Keypad lock				●	●	●	○	○				
User levels				●	●	●	●	●	○	○	○	●
Skip-button for segment jump				●	●	●			●	●	●	●
Program entry in steps of 1 °C or 1 min.	●	●	●	●	●	●	●	●	●	●	●	●
Start time configurable (e. g. to use night power rates)				●	●	●			●	●	●	●
Switch-over °C/F	○	○	○	●	●	●	○	○	●	● ³	● ³	● ³
kWh meter				●	●	●						
Operating hour counter				●	●	●			●	●	●	●
Set point output			○	●	●	●	○	○		○	○	○
NTLog Comfort for HiProSystems: recording of process data on an external storage medium									○	○	○	
NTLog Basic for Nabertherm controller: recording of process data with USB-flash drive				●	●	●						
Interface for VCD software				○	○	○	○	○				
Malfunction memory				●	●	●			●	●	●	●
Number of selectable languages				24	24	24						
Wi-Fi-capable („MyNabertherm" app)				●	●	●						

¹ Not for melt bath control

² Control of additional separate slave regulators possible

³ Depending on the design

● Standard

○ Option

Which Controller for Which Furnaces?

	WK	TR	KTR	NA .. LS	TR .. LS	KTR .. LS	NAT	NA 120/45 - NA 675/85	NA > 1000 l, N .. HA	SAL	SAH	S	W .. A	N 7/H - N 87 .. /H .. /HR	N 81(/..) - N 641(/..)	N 731 - N 2401	WS	WB	NB	H .. /LB, H .. /LT	DH	D	D .. S	FS
Catalog page	14	16	18	25	27	28	32	34	36	40	41	42	44	48	48	50	52	54	55	56	60	62	65	69
Controller																								
R7		●																						
B500	●		●				●	●	●	●	○		●	●	●	●								
B510		○			●		●																	
C540	○		○				○	○	○	○	●	●	○	○	○	○				●				
C550		○			○																			
P570	○		○	●		●	○	○	○	○	○		○	○	○	○	●			○				
P580		○			○																			
3208			○					○		○	○				○	○					●	●	●	
3504		○	○					○		○	○				○	○		● ³	● ³					
H500/SPS								○		○	○				○	○								
H1700/SPS			○			○		○	○	○	○				○	○		● ³	● ³	○	○	○	○	●
H3700/SPS			○					○	○	○	○				○	○		○	○	○	○	○	○	○
NCC			○					○	○	○	○		○	○	○	○		○	○	○	○	○	○	○

Mains Voltages for Nabertherm Furnaces

1-phase: all furnaces are available for mains voltages from 110 V - 240 V at 50 or 60 Hz.

3-phase: all furnaces are available for mains voltages from 200 V - 240 V or 380 V - 480 V, at 50 or 60 Hz.

The connecting rates in the catalog refer to the standard furnace with 400 V (3/N/PE) respectively 230 V (1/N/PE).

Process Data Storage and Data Input via PC



There are various options for evaluation and data input the processes for optimal process documentation and data storage. The following options are suitable for data storage when using the standard controllers.

Data Storing of Nabertherm Controllers with NTLog Basic

NTLog Basic allows for recording of process data of the connected Nabertherm Controller (B500, B510, C540, C550, P570, P580) on a USB stick. The process documentation with NTLog Basic requires no additional thermocouples or sensors. Only data recorded which are available in the controller. The data stored on the USB stick (up to 130,000 data records, format CSV) can afterwards be evaluated on the PC either via NTGraph or a spreadsheet software used by the customer (e.g. Excel™ for MS Windows™). For protection against accidental data manipulation the generated data records contain checksums.

Visualization with NTGraph for MS Windows™ for Single-Zone Controlled Furnaces

The process data from NTLog can be visualized either using the customer's own spreadsheet program (e.g. Excel™ for MS Windows™) or NTGraph for MS Windows™ (Freeware). With NTGraph Nabertherm provides for an additional user-friendly tool free of charge for the visualization of the data generated by NTLog. Prerequisite for its use is the installation of the program Excel™ for MS Windows™ (from version 2003). After data import presentation as diagram, table or report can be chosen. The design (color, scaling, reference labels) can be adapted by using prepared sets. NTGraph is available in eight languages (DE/EN/FR/ES/IT/CN/RU/PT). In addition, selected texts can be generated in other languages.

Software NTEdit for MS Windows™ for Entering Programs on the PC

By using the software NTEdit for MS Windows™ (Freeware) the input of the programs becomes clearer and thus easier. The program can be entered on customers PC and then be imported into the controller (B500, B510, C540, C550, P570, P580) with a USB stick. The display of the set curve is tabular or graphical. The program import in NTEdit is also possible. With NTEdit Nabertherm provides a user-friendly free tool. A prerequisite for the use is the client installation of Excel™ for MS Windows™ (from version 2007). NTEdit is available in eight languages (DE/EN/FR/ES/IT/CN/RU/PT).



NTGraph, a freeware for the easy-to-read analysis of recorded data using Excel™ for MS Windows™



Recording of process data of the connected controller via USB stick



Process input via the NTEdit software (freeware) for MS Windows™

Process Data Storage

VCD-software for visualization, control and documentation

Documentation and reproducibility are more and more important for quality assurance. The powerful VCD software represents an optimal solution for single multi furnace systems as well as charge documentation on the basis of Nabertherm controllers.

The VCD software is used to record process data of the series 500 and series 400 as well as various further Nabertherm controllers. Up to 400 different heat treatment programs can be stored. The controllers are started and stopped via the software at a PC. The process is documented and archived accordingly. The data display can be carried-out in a diagram or as data table. Even a transfer of process data to Excel™ for MS Windows™ (.csv format *) or the generation of reports in PDF format is possible.



Example lay-out with 3 furnaces

Features

- Available for controllers series 500 - B500/B510/C540/C550/P570/P580, series 400 - B400/B410/C440/C450/P470/P480, Eurotherm 3504 and various further Nabertherm controllers
- Suitable for operating systems Microsoft Windows 7/8/10/11
- Simple installation
- Setting, Archiving and print of programs and graphics
- Operation of controllers via PC
- Archiving of process curves from up to 16 furnaces (also multi-zone controlled)
- Redundant saving of archives on a server drive
- Higher security level due to binary data storage
- Free input of charge date with comfortable search function
- Possibility to evaluate data, files exportable to Excel™ for MS Windows™
- Generation of a PDF-report
- 24 languages selectable

Extension Package 1 for display of an additional temperature measuring point, independent of the furnace controls

- Connection of an independent thermocouple, type S, N or K with temperature display on a supplied C6D display, e. g. for documentation of charge temperature
- Conversion and transmission of measured values to the VCD software
- For data evaluation, please see VCD-software features
- Display of measured temperature directly on the extension package

Extension Package 2 for the connection of up to three, six or nine measuring point, independent of the furnace controls

- Connection of three thermocouples, type K, S, N or B to the included connecting box
- Possible extension of up to two or three connecting boxes with up to nine measuring points
- Conversion and transmission of measured values to the VCD software
- Data evaluation, see VCD features



VCD Software for Control, Visualisation and Documentation



Graphic display of main overview (version with 4 furnaces)

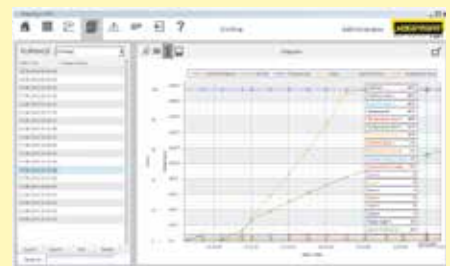

Graphic display of process curve

PLC Controls HiProSystems



This professional process control with PLC controls for single and multi-zone furnaces is based on Siemens hardware and can be adapted and upgraded extensively. HiProSystems control is used when process-dependent functions, such as exhaust air flaps, cooling fans, automatic movements, etc., have to be handled during a cycle, when furnaces with more than one zone have to be controlled, when special documentation of each batch is required and when remote service is required. It is flexible and is easily tailored to your process or documentation needs.

Alternative User Interfaces for HiProSystems

Process Control H500

This basic panel accommodates most basic needs and is very easy to use. Firing cycle data and the extra functions activated are clearly displayed in a table. Messages appear as text. Data can be stored on a USB stick using the „NTLog Comfort“ option.

Process Control H1700

Customized versions can be realized in addition to the scope of services of the H500. Display of basic data as online trend on a color 7" display with graphically structured interface.

Process Control H3700

Display of functions on a large 12" display. Display of basic data as online trend or as a graphical system overview. Scope as H1700.

Remote Maintenance Router – Fast Support in Case of a Malfunction

For fast failure diagnosis in case of a malfunction, remote maintenance systems are used for HiProSystems-plants (depending on the model). The plants are equipped with a router, which will be connected to the internet by the customer. In case of a malfunction, Nabertherm is able to get access to the furnace controls via a secured connection (VPN tunnel) and to perform a malfunction diagnosis. In most cases, the problem can be directly solved by a technician on site according with supervision from Nabertherm.

If no Internet connection can be provided, we offer optionally the remote maintenance via LTE network as additional equipment.



H1700 with colored, tabular depiction



H3700 with colored graphic presentation



Router for remote maintenance

Process Data Storage



The following options are available for industrial process documentation and the recording of data from several furnaces. These can be used to document the process data for the PLC controls.



NTLog Comfort for data recording of a Siemens PLC via USB stick

Data Storing of HiProSystems with NTLog Comfort

The extension module NTLog Comfort offers the same functionality of NTLog Basic module. Process data from a HiProSystems control are read out and stored in real time on a USB stick. The extension module NTLog Comfort can also be connected using an Ethernet connection to a computer in the same local network so that data can be written directly onto this computer.

Temperature Recorder

Besides the documentation via the software which is connected to the controls, Nabertherm offers different temperature recorders which can be used with respect to the application.

	Model 6100e	Model 6100a	Model 6180a
Data input using touch panel	x	x	x
Size of colour display in inch	5.5"	5.5"	12.1"
Number of thermocouple inputs	3	18	48
Data read-out via USB-stick	x	x	x
Input of charge data		x	x
Evaluation software included	x	x	x
Applicable for TUS-measurements acc. to AMS2750G			x

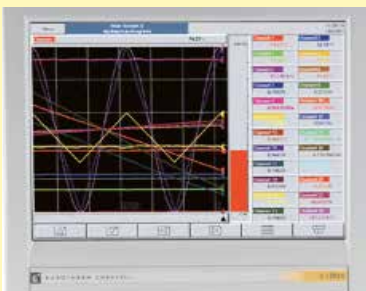

Temperature recorder

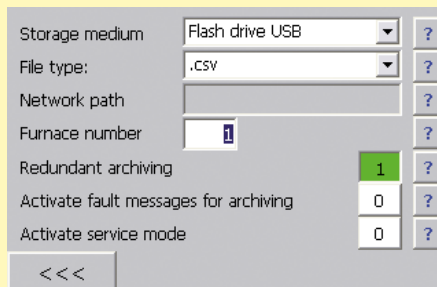

NTLog Comfort - Data recording via USB stick

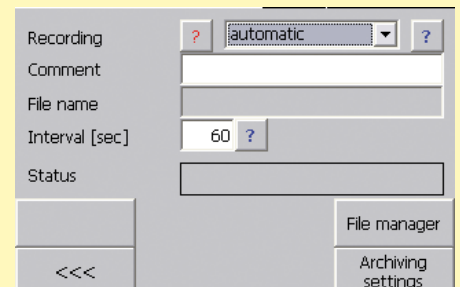

NTLog Comfort - Data recording online on the PC

Nabertherm Control Center NCC

PC-based control, process visualization and process documentation software

The Nabertherm Control Center as PC-supported furnace controls offers an ideal extension for furnaces with PLC based HiProSystem controls. The system has proven itself in many applications with increased demands on documentation and process reliability and also for convenient multi-furnace management. Many customers from the automotive, aviation, medical technology or technical ceramics sectors have been working successfully with this powerful software.



Retort furnace NR 300/08 for treatment in high vacuum

Standard Equipment

- Central furnace management
- Graphical furnace overview of up to 8 furnaces
- Tabular, clear program entry (100 program locations)
- Charge administration (article, quantity, additional information)
- Connection to the company network
- Adjustable access rights
- Online monitoring of the heat treatment
- Tamper-proof documentation
- Malfunction message list, adapted to the furnace model
- Archive function
- Scope of delivery includes PC and printer
- Measuring range calibration of up to 18 temperatures per measurement point. Multi-stage calibration is possible for applications with normative requirements.

Additional Equipment

- Reading in charge data via barcode
 - Simple data acquisition, ideal for frequently changing charges
 - Defined charge data ensures data quality
- Recipe storage with charge comparison
 - Comparison of charge and recipe to increase process reliability
- Adaptable access rights or access rights via employee cards
- Software extension to fulfill documentation requirements according to norms like AMS2750G (NADCAP), CQI9 or Food and Drug Administration (FDA), Part 11, EGV 1642/03
- Interface for connection to overriding systems
- SQL connection
- Redundant data storage
- Cellular connection or network connection for notification via SMS, e. g. in the event of malfunctions
- Control from different PC workstations
- Configuration as industrial PC or virtual machine
- PC cabinet
- UPS for PC
- Customization according to individual requirements



Retort furnace NR 80/11 with IDB safety concept for debinding under non-flammable protective gases



System overview

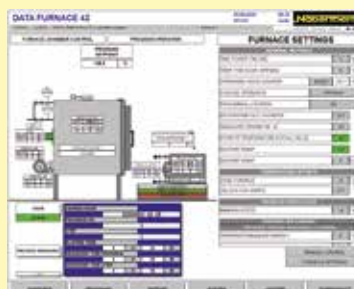

Furnace overview



Measurement range calibration

Temperature Uniformity and System Accuracy

Temperature uniformity is defined as the maximum temperature deviation in the work space of the furnace. There is a general difference between the furnace chamber and the work space. The furnace chamber is the total volume available in the furnace. The work space is smaller than the furnace chamber and describes the volume which can be used for charging.



Holding frame for measurement of temperature uniformity

Specification of Temperature Uniformity in \pm K in the Standard Furnace

In the standard design the temperature uniformity is specified in \pm K at a defined set-temperature with the work space of the empty furnace during the dwell time. In order to make a temperature uniformity survey the furnace should be calibrated accordingly. As standard our furnaces are not calibrated upon delivery.

Calibration of the Temperature Uniformity in \pm K

If an absolute temperature uniformity at a reference temperature or at a defined reference temperature range is required, the furnace must be calibrated appropriately. If, for example, a temperature uniformity of \pm 5 K at a set temperature of 750 °C is required, it means that measured temperatures may range from a minimum of 745 °C to a maximum of 755 °C in the empty work space.

System Accuracy

Tolerances may occur not only in the work space, they also exist with respect to the thermocouple and in the controls. If an absolute temperature uniformity in \pm K at a defined set temperature or within a defined reference working temperature range is required, the following measures have to be taken:

- Measurement of total temperature deviation of the measurement line from the controls to the thermocouple
- Measurement of temperature uniformity within the work space at the reference temperature or within the reference temperature range
- If necessary, an offset is set at the controls to adjust the displayed temperature at the controller to the real temperature in the furnace
- Documentation of the measurement results in a protocol

Temperature Uniformity in the Work Space incl. Protocol

In standard furnaces, temperature uniformity is guaranteed as \pm K without measurement of temperature uniformity. However, as an additional feature, a temperature uniformity measurement at a target temperature in the work space compliant with DIN 17052-1 can be ordered. Depending on the furnace model, a holding frame which is equivalent in size to the work space is inserted into the furnace. This frame holds thermocouples at up to 11 defined measurement positions. The measurement of the temperature uniformity is performed at a target temperature specified by the customer after a static condition has been reached. If necessary, different target temperatures or a defined target working temperature range can also be calibrated.



Pluggable frame for measurement for forced convection chamber furnace N 7920/45 HAS

The system accuracy is defined by adding the tolerances of the controls, the thermocouple and the work space



Precision of the controls, e. g. \pm 1 K

Deviation of thermocouple, e. g. \pm 1.5 K

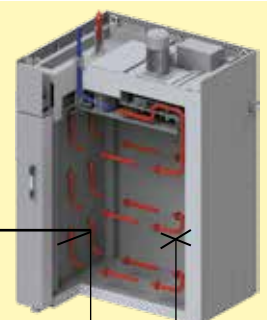

Deviation from measuring point to the average temperature in the work space e. g. \pm 3 K

AMS2750F, NADCAP, CQI-9

Standards such as the AMS2750F (Aerospace Material Specifications) are applicable for the industrial processing of high-quality materials. They define industry-specific requirements for heat treatment. Today, the AMS2750F and derivative standards such as AMS2770 for the heat treatment of aluminum are the guidelines for the aerospace industry. After the introduction of the CQI-9, the automotive industry has also committed to submit heat treatment processes to stricter rules. These standards describe in detail the requirements applicable to thermal processing plants.

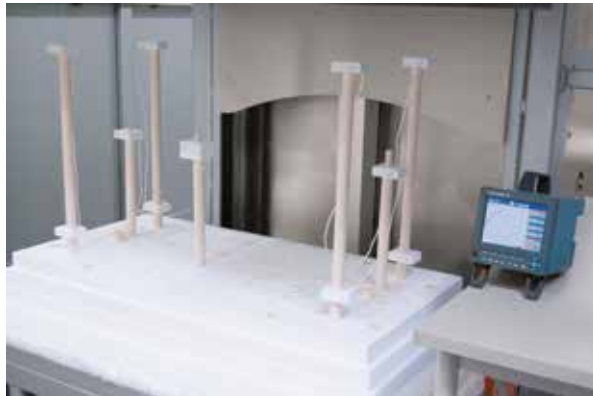

Measurement set-up in a high-temperature furnace

- Temperature uniformity in the work space (TUS)
- Instrumentation (definition of measurement and control systems)
- Calibration of the measurement system (IT) from the controller via the measurement line to the thermocouple
- Inspections of system accuracy (SAT)
- Documentation of the inspection cycles

Norm compliance is necessary to ensure that the required quality standard of the manufactured components can also be reproduced in series. For this reason, extensive and repeated inspections as well as controls of the instrumentation, including the relevant documentation, are required.

Furnace Class and Instrumentation Requirements of the AMS2750F

Depending on the quality requirements of heat treatment job the customer specifies instrumentation type and the temperature uniformity class. The instrumentation type describes the necessary combination of the applied control, recording media as well as thermocouples. The temperature uniformity of the furnace and the class of the selected instrumentation are defined based on the required furnace class. The higher the requirements are set for the furnace class the more precise the instrumentation must be.

Regular Inspections

The furnace or the heat treatment plant must be designed so that the requirements of the AMS2750F can be met and be reproduced. The standard also requires the inspection intervals for the instrumentation (SAT = System Accuracy Test) and the temperature uniformity of the furnace (TUS = Temperature Uniformity Survey). The SAT/TUS tests must be performed by the customer with measuring devices and sensors which operate independently of the furnace instrumentation.

Instrumentation	Type						Furnace class	Temperature uniformity	
	A	B	C	D+	D	E		°C	°F
Each control zone has a thermocouple connected to the controller	x	x	x	x	x	x	1	+/- 3	+/- 5
Recording of the temperature measured by the control thermocouple	x	x	x	x	x		2	+/- 6	+/- 10
Sensors for recording the coldest and hottest spots			x				3	+/- 8	+/- 15
Each control zone has a charge thermocouple with recording system	x	x					4	+/- 10	+/- 20
One additional recording sensor, distance ≥ 76 mm to control sensor, of a different sensor type				x			5	+/- 14	+/- 25
Each control zone has an over-temperature protection unit	x	x	x	x	x		6	+/- 28	+/- 50



Measurement set-up in an annealing furnace



Measuring protocol

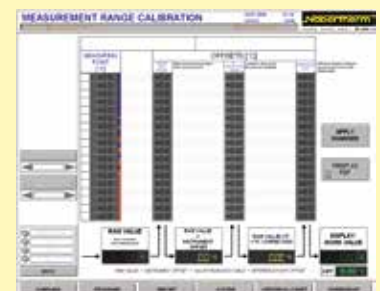

Measurement range calibration

AMS2750F, NADCAP, CQI-9

The suitable furnace model for the corresponding heat treatment can be designed based on the process, the charge, the required furnace class and the type of instrumentation. Depending on the required specs, alternative solutions can be offered.



N 12012/26 HAS1 according to AMS2750F

- Furnace designs, which meet standards, following customer specifications regarding furnace class and instrumentation, incl. gauge connections for repeated customer inspections at regular intervals. No consideration of requirements with respect to documentation
- Data recording devices (e.g., temperature recorder) for TUS and/or SAT measurements see page 92
- Data recording, visualization, time management via the Nabertherm Control Center (NCC), based on Siemens WinCC software see page 93
- Commissioning at site, incl. the first TUS and SAT inspection
- Connection of existing furnace plant to meet norm requirements
- Documentation of the complete process chain in line with the corresponding norm

Implementation of AMS2750F

Basically, two different systems are available for control and documentation, a proven Nabertherm system solution or instrumentation using Eurotherm controllers/temperature recorders. The Nabertherm AMS package is a convenient solution that includes the Nabertherm Control Center for control, visualization, and documentation of the processes and test requirements based on PLC controls.

Instrumentation with Nabertherm Control Center (NCC)

The attractive feature of the instrumentation with Nabertherm Control Center in combination with PLC controls of the furnace is the convenient data input and visualization. The software programming is structured in a way that both the user and the auditor can navigate it without difficulty.



In daily use, the following product characteristics stand out:

- Very easy to navigate and straight-forward presentation of all the data in plain text on the PC
- Automatic saving of the charge documentation at the end of the program
- Administration of the calibration cycles in the NCC
- Results of the measurement distance calibration are entered in the NCC
- Schedule management of the required testing cycles including a reminder function. The testing cycles for TUS (Temperature Uniformity Survey) and SAT (System Accuracy Test) are entered in days and monitored by the system and the operator or tester is informed in time about up-coming tests. The measurements have to be done with separate calibrated measuring equipment.
- Option of transferring the measurement data to a customer's server

The Nabertherm Control Center can be extended to enable a complete documentation of the heat treatment process apart from just the furnace data. For example, when heat-treating aluminum, in addition to the furnace, the temperatures in the quenching basin or a separate cooling medium can also be documented.

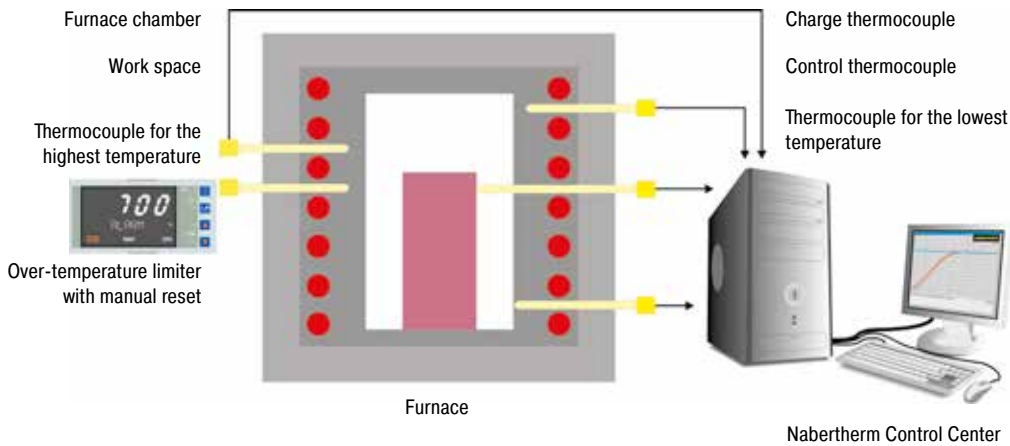

Example of a design with Type A Nabertherm Control Center

Alternative Instrumentation with Temperature Controllers and Recorders from Eurotherm

As an alternative to instrumentation with the Nabertherm Control Center (NCC) and PLC controls, instrumentation with controllers and temperature recorders is also available. The temperature recorder has a log function that must be configured manually. The data can be saved to a USB stick and be evaluated, formatted, and printed on a separate PC. Besides the temperature recorder, which is integrated into the standard instrumentation, a separate recorder for the TUS measurements is needed (see page 92).

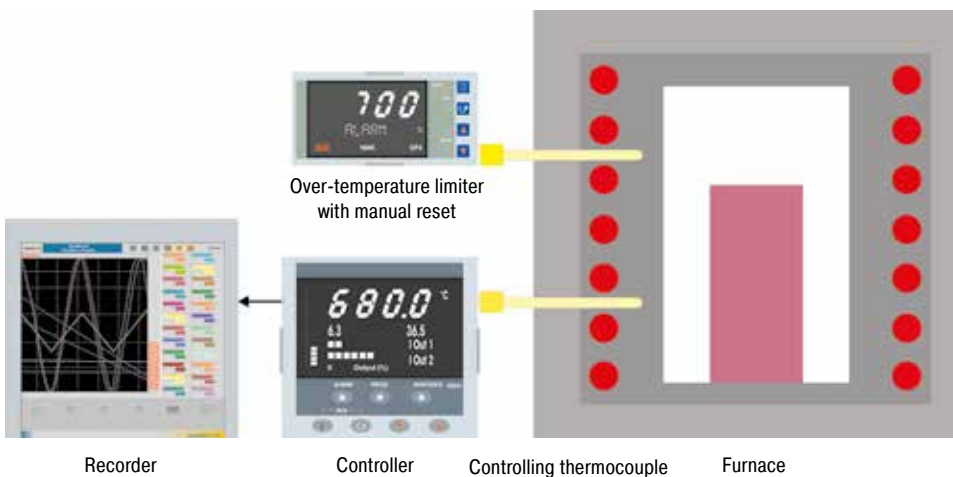

Example of a design containing Type D Eurotherm instrumentation

Furnace Chamber Control

Only the furnace chamber temperature is measured and controlled. Regulation is carried out slowly to avoid out-of-range values. As the charge temperature is not measured and controlled, it may vary a few degrees from the chamber temperature.

Charge Control

If the charge control is switched on, both the charge temperature and furnace chamber temperature are measured. By setting different parameters the heat-up and cooling processes can be individually adapted. This results in a more precise temperature control at the charge.

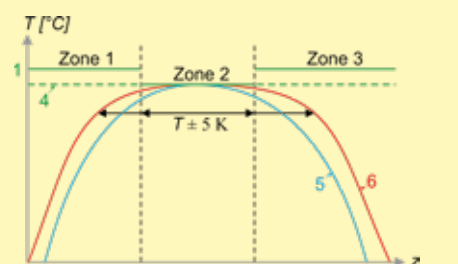
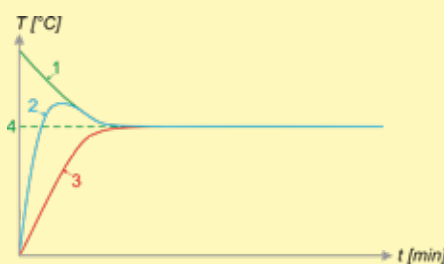
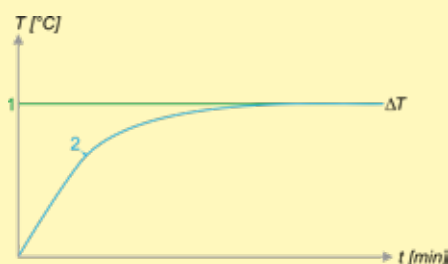

1. Set value furnace chamber
2. Actual value furnace chamber
3. Actual value charge
4. Set value charge
5. Actual value furnace chamber single zone
6. Actual value furnace chamber three zone



Spare Parts and Customer Service — Our Service Makes the Difference

For many years the name **Nabertherm** has been standing for top quality and durability in furnace manufacturing. To secure this position for the future as well, Nabertherm offers not only a first-class spare parts service, but also excellent customer service for our customers. Benefit from more than 70 years of experience in furnace construction.

In addition to our highly qualified service technicians on site, our service specialists in Lilienthal are also available to answer your questions about your furnace. We take care of your service needs to keep your furnace always up and running. In addition to spare parts and repairs, maintenance and safety checks as well as temperature uniformity measurements are part of our service portfolio. Our range of services also includes the modernization of older furnace systems or new linings.

The needs of our customers always have highest priority!



- Very fast spare parts supply, many standard spare parts in stock
- Worldwide customer service on site with its own service points in the largest markets
- International service network with long-term partners
- Highly qualified customer service team for quick and reliable repair of your furnace
- Commissioning of complex furnace systems
- Customer training in function and operation of the system
- Temperature uniformity measurements, also according to standards like AMS2750F (NADCAP)
- Competent service team for fast help on the phone
- Safe teleservice for systems with PLC controls via modem, ISDN or a secured VPN line
- Preventive maintenance to ensure that your furnace is ready for use
- Modernization or relining of older furnace systems

Contact us:

Spare parts



spares@nabertherm.de



+49 (4298) 922-474

Customer service



service@nabertherm.de



+49 (4298) 922-333



The whole World of Nabertherm: www.nabertherm.com

Please visit our website www.nabertherm.com and find out all you want to know about us - and especially about our products.

In addition to current information and exhibition dates, there is of course the possibility of direct contact or an authorized dealer from our worldwide dealer network.

Professional Solutions for:

- Thermal Process Technology
- Additive Manufacturing
- Advanced Materials
- Fiber Optics/Glass
- Foundry
- Laboratory
- Dental
- Arts & Crafts

Headquarters

Nabertherm GmbH
Bahnhofstr. 20
28865 Lilienthal, Germany
Tel +49 4298 922 0
contact@nabertherm.de

Sales Organisation

China
Nabertherm Ltd. (Shanghai)
No. 158, Lane 150, Pingbei Road, Minhang District
201109 Shanghai, China
Tel +86 21 64902960
contact@nabertherm-cn.com

France
Nabertherm SARL
20, Rue du Cap Vert
21800 Quetigny, France
Tel +33 6 08318554
contact@nabertherm.fr

Great Britain
Nabertherm Ltd., United Kingdom
Tel +44 7508 015919
contact@nabertherm.com

Italy
Nabertherm Italia
via Trento N° 17
50139 Florence, Italy
Tel +39 348 3820278
contact@nabertherm.it

Switzerland
Nabertherm Schweiz AG
Altgraben 31 Nord
4624 Härkingen, Switzerland
Tel +41 62 209 6070
contact@nabertherm.ch

Benelux
Nabertherm Benelux, The Netherlands
Tel +31 6 284 00080
contact@nabertherm.com

Spain
Nabertherm España
c/Marti i Julià, 8 Bajos 7ª
08940 Cornellà de Llobregat, Spain
Tel +34 93 4744716
contact@nabertherm.es

USA
Nabertherm Inc.
64 Reads Way
New Castle, DE 19720, USA
Tel +1 302 322 3665
contact@nabertherm.com



All other Countries: Follow
<https://www.nabertherm.com/contacts>